

**DPS PERSONAL
ANIMATION RECORDER**

NTSC
AMIGA Version



DIGITAL
PROCESSING SYSTEMS INC.

Information in this document is subject to change without notice and does not represent a commitment on the part of Digital Processing Systems Inc.

This product requires technical and mechanical ability and requires precautions against electrostatic discharge. The user assumes all risks when this product is assembled by anyone other than an authorized Digital Processing Systems dealer.

This manual, the Personal Animation Recorder, distribution disks and all related material are Copyright© 1993, Digital Processing Systems Inc. All rights reserved. No part of this publication may be reproduced or transmitted in any form or by any means, electronic or mechanical, including photocopy, recording or any information storage or retrieval system, without permission in writing from the publisher.

U.S.A.
Digital Processing Systems Inc.
11 Spiral Drive, Suite 10
Florence, KY 41042
(606) 371-5533
Fax: (606) 371-3729

Canada / International
Digital Processing Systems Inc.
50 Tiffield Road
Scarborough, Ontario
Canada M1V 5B7
(416) 754-8090
Fax: (416) 754-7046

Europe
Digital Processing Systems Ltd.
Riverside Business Park, Unit 2
Dogflud Way, Farnham
Surrey, GU9 7SS U.K.
(0252) 718300
Fax: (0252) 718400

DPS Part No. 707-890
Release Version 1.6
December 1994

The DPS Personal Animation Recorder and the DPS Personal TBC IV are registered trademarks of Digital Processing Systems, Inc. Video Toaster and Lightwave 3D are trademarks of NewTek, Inc. Amiga, AmigaDOS and Workbench are trademarks of Commodore-Amiga, Inc. Ami-Back is a registered trademark of Moonlighter Software Development, Inc.

Digital Processing Systems

Bulletin Board System

For DPS customers with modems, software upgrades and new product information is available by calling our Bulletin Board System at (416) 754-8368. The settings in your favorite communications package should be set as follows:

Speed	up to 14,4000 bps
Terminal Type	VT-102/ANSI
Data Bits	8
Pairty	None
Stop Bits	1

Recommended Settings

Transfer Protocol	ZMODEM
Handshaking	Hardware (CTS/RTS)

New callers will be asked to answer a short questionnaire. After answering all questions, you may choose to read the Bulletins and Newsletter or go directly to the file transfer menu and download the required file(s).

The BBS contains extensive help files should you have difficulty using the system. Otherwise, please refer questions on using your modem to the organization where you purchased your communications software or your local dealer.

TABLE OF CONTENTS

Introduction

What is PAR?	7
PAR Features.....	7
Background: Why the PAR?	8

Chapter 1 - Getting Started With the Personal Animation Recorder

System Requirements	11
Unpacking and Inspection.....	12
Installation.....	12
Installing the Hard Drive.....	12
Installing the PAR Card.....	13
Using the GPI Trigger for Controlling the Pause Button	14
Installing the TBC IV with the PAR Card	15

Chapter 2 - Video Connections

Figure 2-1 - PAR I/O Connections.....	19
Figure 2-2 - TBC-IV I/O Connections	20
Figure 2-3 - PAR Output Connections.....	22
Figure 2-4 - Connecting the PAR to the Video Toaster	23
Figure 2-5 - Using the PAR Card with the Personal TBC IV Card	24
Figure 2-6 - Using a Camera for a Genlock Reference	25
Figure 2-7 - Using the PAR Card with two Personal TBC III Cards	26
Figure 2-8 - Using Betacam or CAV Recording Equip.	27
Figure 2-9 - Using a TBC IV for Video Capture with a TBC III	28
Figure 2-10 - Using an additional TBC IV	29

Chapter 3 - Installing PAR Software

Installing PAR Software from the AMIGA Workbench.....	31
Installing PAR Software in Autoboot Toaster Systems.....	31
Starting PAR Software	33
Formatting the PAR Hard Drive	34
Quitting from PAR Software	35
Setting up Communication to the TBC IV via the PAR Card	35

Chapter 4 - The PAR Project Manager Screen: Basic Concepts	
PAR User Interface.....	37
Screen Layout	37
The File Management Windows and Requesters	38
The AmigaDos Files Requester	38
Navigating Through AmigaDos Devices and Subdirectories	39
Selecting Image Files to be Copied and Converted by PAR	40
View, All, Clear, Import, Increment, Multiply	
Anim/Still, Imp/Exp Controls	
Translate	43
Using the Translate feature with Lightwave 3D.....	43
Field Handling.....	44
Export File Formats.....	45
Chroma Filter.....	46
The PAR Projects and Files Requesters	47
PAR Projects Requester	47-49
New Project, Delete, Chart, Map, Cleanup,	
Master/Slave, Rename Controls	
PAR Files Requester	50
Dup, Split, Join, Append, Export Controls	52-56
The PAR Record/Playback Deck.....	59
Playback controls: Play, Pause, Stop, Rew, FF, frame incr,	
frame decrSlow motion playback	57-61
Field/Frame mode.....	62
GPI.....	62
Film Mode	63
Smpte	64
The File Compression Controls (Image Quality).....	65
Q-Factor	66
Block Limit	67
The System Controls (Preferences).....	68
Betacam/MII Modes.....	68
Genlock Timing, Controls	69

Chapter 5 - Using PAR for Animation Recording	
Introduction	71
Animation Recording: Two Ways to Go	71
Direct Capture Method	72
Intermediate File Method	76
Chapter 6 - Using PAR for Capturing Video	
Introduction	79
Still Frame Grabs	79
Video Recording	82
Normal Recording.....	84
Stunt Recording.....	84
Time Lapse Recording	85
Manual Frame Recording	86
Play-N-Grab	88
Chapter 7 - Using PAR for Still Frame Storage	
Introduction	91
How to Use Par for Still Frame Storage.....	91

Appendix A	
Compatible Hard Drives and Recommended Block Limits	93
Appendix B	
Specifications	101
Appendix C	
Keyboard Hotkeys	105
Appendix D	
ARexx Commands	107
ARexx Command Reference.....	122
Appendix E	
Troubleshooting.....	125
Appendix F	
FCC Compliance Statement.....	129
Appendix G	
Warranty.....	131
Limitations	131
Warranty Service	132

INTRODUCTION

Congratulations and thank you for purchasing the DPS Personal Animation Recorder! We at Digital Processing Systems are proud of this revolutionary product; we believe that you'll be very satisfied with its unparalleled features and performance.

This introductory section gives you an overview of what the Personal Animation Recorder is, and some of the background as to why it was created.

What is the Personal Animation Recorder?

The Personal Animation Recorder (or PAR, for short) is a revolutionary tool for computer animators. Used in conjunction with your Amiga computer and animation rendering software, it eliminates the need for a single-frame videotape recorder and controller, while giving you real-time playback of full resolution animation sequences.

PAR is actually three tools in one: an animation record/playback deck, a real-time video capture deck for rotoscoping, and a still store with stunning access speed and storage efficiency. You'll find many applications for it, including:

- Computer animation
- Camera animation
- Rotoscoping
- Time lapse video recording
- Still frame (from camera or computer) storage and retrieval

Some of the many features of the Personal Animation Recorder are:

- Accepts animation frames directly from rendering program
- Copies existing image files from Amiga disk drive
- Compatible with IFF, Targa, SGI or Video Toaster Framestore files
- Switchable filter to prevent chrominance aliasing from IFF files
- Project organizer for image and animation files
- Real time video capture with variable frame rate, and still grabs (when used with TBC-IV card, not supplied)
- Animation editing features: join, split, duplicate, ping-pong, reverse, etc

- General Purpose Interface for triggered playback from edit controller
- Variable speed playback
- Genlockable video outputs with variable timing
- Video output formats: composite NTSC, S-VHS, Betacam or MII
- Direct access to TBC-IV control screen

Background: Why the PAR?

For most applications, computer-generated animations have to be transferred to videotape in order to be useful. However, unless you have a supercomputer, animation rendering in real time (at the video rate of 30 frames per second) is not possible. In fact, using a personal computer, rendering each frame of animation can take 30 minutes or more! Therefore, the recording of an animation calls for a videotape recorder (VTR) which is capable of single frame recording. Such machines are much more sophisticated than consumer VCRs, and typically cost upwards of \$15,000. In addition, a device called a single frame controller is required to coordinate the recording process.

Each time the computer has finished rendering a frame of the animation, the controller tells the VTR to move the tape back and forth until it is precisely positioned one frame beyond the recording so far. It does this by reading a time code that was previously recorded onto the tape (even on frames with no video recorded on them yet). The new frame is recorded onto tape; the VTR then idles for half an hour until the next frame is ready.

Obviously, there is a lot of wear and tear on the machine's transport mechanism. For example, in order to record a 3 minute animation, the VTR goes through more than 5,000 cycles of activating its solenoids, slamming all its levers, belts and cogs, and stretching the tape. Also, the heads (which can cost over \$4,000 to replace) very quickly get a lot of hours on them, increasing the likelihood of bad frames. Because of the required 5 second pre-roll, each spot on the tape is going through the transport 150 times while recording. A lot of things can go wrong, resulting in poor technical quality, missed deadlines, and high blood pressure.

The solution, at least in principle, has long been obvious. Since the animation frames are rendered on a computer, why not use the computer's disk drive to store them? When they're all finished, just play them at normal video speed, and record the result with a conventional VTR. If there any glitches occurred in the recording, just tape it again.

Hardware and software to do this is quite simple to create, if you're willing to settle for low-resolution, limited palette graphics. But if you're looking for 752 x 480 resolution, 16 million colors, component video and 30 frames per second, there's a serious problem: computer disk drives can't possibly keep up with the data transfer speeds required.

Also, there's the question of size: a single frame of high-quality animation can take 700 Kbytes of memory. Multiply this by 30 frames per second, and you'll quickly see that a lot of disk is required for an animation. For example, a three minute show would need almost 4 gigabytes! And think how long it would take to make a backup!

The DPS Personal Animation Recorder breaks through those obstacles. It is a single card that plugs into your Amiga computer (along with a dedicated hard disk drive) to give you true hard disk recording of professional-quality animations. The powerful PAR Project Manager software gives you instant access to all of your animation files, along with a "virtual videotape deck" with controls similar to a VTR -- but they work a lot faster!

At last, you can put away your single frame VTR, along with its unreliability and high maintenance costs and you can concentrate on doing what you do best.



CHAPTER 1

Getting Started

System Requirements

You will require the following items in order to use the Personal Animation Recorder:

- Personal Animation Recorder card, software and supplied accessories (see the section on “unpacking and inspection” for list of supplied accessories)
- High-capacity hard drive dedicated to Personal Animation Recorder. Refer to Appendix A for recommended hard drives.
- Amiga 2000, 3000 or 4000 computer with:
- A hard drive with at least 250 Kbytes available for PAR software
- At least 1.2 Mbytes of system memory available to PAR
- Workbench 2.0 or higher.

Note: Some software programs running on your Amiga may attempt to use all of the available memory. You may have to configure such programs to limit their maximum memory usage.

- Animation rendering software such as LightWave 3D, Morph Plus, etc.
- Video monitor and VCR
- Optional: Digital Processing Systems TBC-IV card, if you are using your PAR card for video capture

Unpacking and Inspection

This unit has been thoroughly calibrated and inspected, both electrically and mechanically, to ensure that it meets the published specifications. The following items are included with each DPS Personal Animation Recorder:

<u>Qty</u>	<u>Description</u>
1	DPS Personal Animation Recorder
1	Operations Manual
1	Software Disk
1	24" 40 Pin IDE Ribbon Cable
1	4" 50 Pin Ribbon Cable
1	Hard Disk Power "Y" Cable
1	Genlock "Loop Through" Cable
1	Null Modem Jumper

We suggest that you retain all original packing materials. This will facilitate reshipment should it ever become necessary.

Don't install the hard drive upside down in your computer. This will cause a significant reduction in the drives performance and will prevent it from operating with the PAR card.

Installation

CAUTION: In the interest of personal safety and to prevent damage to the cards, disconnect power before servicing this unit. Refer service to qualified personnel.

Refer to the instructions accompanying your computer for instructions on removing the top cover.

Hard Drive Installation

The DPS Personal Animation Recorder requires the use of a dedicated internal IDE type hard drive (not included). A controller card is not required for this hard drive. Install this hard drive in your computer where space will accommodate. Do not install the drive upside down. See appendix A for additional information about hard drives.

Genlock Termination Jumper

This jumper, labeled EHE2 on the card, allows the genlock video input to be either high impedance or terminated in 75Ω. This jumper is normally not installed, which makes the genlock video input high impedance, allowing the signal to be “looped” using the supplied genlock “loop through” cable. If the PAR card is the last device on a genlock reference loop, then jumper EHE2 should be installed.

Card Installation

Insert the card and install the screw on the rear panel support bracket. Connect the previously installed hard drive to P3 on the Animation card, using the supplied 24” 40 pin ribbon cable. If you are installing the PAR card and a Personal TBC IV card, you should insert the PAR card in the slot nearest to the IBM type slots. This will allow the use of the Component Video Exchange (CVE) port (P2) for serial control of other DPS products, as well as real time frame capture using the Personal TBC IV.

CAUTION: Observe the correct polarity when connecting the hard drive to the P3 connector on the PAR card. The supplied ribbon cable is keyed and polarized so that only one end will fit into the hard drive. The other end of the ribbon cable is polarized so that it will only fit one way at P3 on the PAR card

If for any reason you need to replace this ribbon cable and have obtained one from a source other than DPS you need to take extra precautions when installing the new cable. The original cable supplied with your PAR board is keyed so that it only fits one way on both the drive and the PAR board. The replacement cable will not be keyed on the end that attaches to the PAR board so install the cable on the hard drive first. If the red stripe on the cable is closest to the power connector on the drive, the red stripe would be oriented

toward the front of the computer after connection to the animation card. If you have installed the ribbon cable on the hard drive so that the red stripe is furthest away from the power connector, then the red stripe would be oriented toward the back of the computer after connection to the animation card. The 4" 50 pin ribbon cable is used to connect the CVE port (P2) to a DPS Personal TBC IV. If you are not installing a TBC IV card, this connector is not used.

Replace the top cover on your computer.

GPI Trigger (General Purpose Interface)

GPI stands for General Purpose Interface, and it lets you "trigger" the playback of the PAR Deck from an external device (such as an edit controller). When the GPI is triggered, the 'Pause' button is released (if it was set).

To use GPI, you'll need to electrically connect your edit controller to the Amiga's 2nd joystick port. The pin which normally means "Joystick Right" (Pin 4) is interpreted by PAR as a trigger to release the 'Pause' button. To trigger it, pin 4 must be connected to pin 8 (ground) for a minimum of 1/60th a second. (This feature may be tested using a joystick and moving it to the right.)

Figure 1-1

**General
Purpose
Interface
Connection**

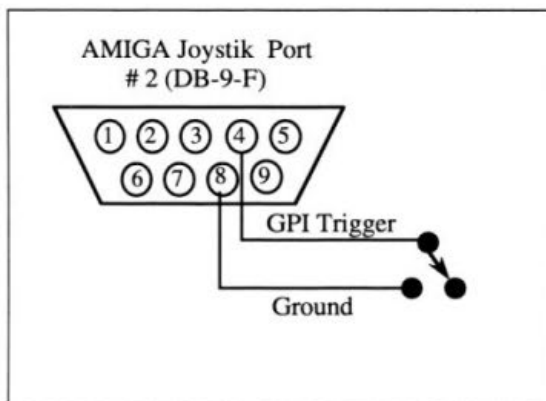

Installing the TBC-IV With the DPS Personal Animation Recorder

First you will have to set the Serial Baud Rate of the TBC-IV to 9600 baud (the TBC-IV card is normally shipped from the factory at a setting of 31,250 baud). To set the board to 9600 baud, simply set DIP switch #2 to the DOWN position. DOWN is towards the board, UP is away from the board. All other switches should be in the UP position. Refer to the section "DIP Switch Settings" if you need further information on the DIP switch.

Next you will have to choose one of the PC slots in your Amiga to install the TBC-IV into. To use the TBC-IV with the PAR board you will have to connect the two together using a standard 50 pin ribbon cable. The cable connects the CVE ports of the two boards directly without any twists. The CVE ports on the board are identified as BHE1 on the TBC-IV and P2 on the PAR board. When the boards are lined up side by side the two connectors will be directly in line with each other. It is easiest to install one end of the 50 pin cable to the TBC-IV prior to inserting the card into the computer. If you wish to use the included short 50 pin ribbon cable to connect your TBC-IV to your PAR card, you will have to install the TBC-IV into an adjacent slot. Choose a PC slot that will allow your ribbon cable to reach the PAR board without any strain. Install the TBC-IV with the ribbon already installed, then connect the other end of the ribbon cable to the PAR board. Make sure at this time that the cables are securely connected and are correctly aligned over the CVE port pins.

The next step is to connect the genlock cable between the TBC-IV and the PAR board. The genlock cable enables you to use the PAR board as the main timing generator for your system. Locate the short black 'Y' cable (video cable) which came with your TBC-IV. Connect the center of this cable to the top BNC of the PAR board. Connect the female end of the Y cable to the bottom BNC of the TBC-IV (GENLOCK in). The other unused connector is now your composite out connector. You will also need to configure the TBC-IV software so that it is set up for use with a PAR board. You now have to configure the TBC-IV software so that it can use the PAR board for communications. From the preferences panel of the TBC-IV software (version 2.5 and higher) you can set the baud rate and port. Choose 'PAR' and the

NOTE: If you're installing the TBC-IV card with the PAR card, as described in this section, remember that you'll have to perform a special software set-up. See the section, "Setting up Communication to the TBC-IV via the PAR Card"

software should automatically choose 9600. You will also have to set the genlock mode to 'Slave'.

About the CVE port and ribbon cable:

In addition to carrying digitized video from the TBC-IV into the PAR, it also carries the on-screen commands from the Amiga CPU, via the PAR, and then to the TBC-IV card.

If you're installing another TBC-IV card, locate the 3", 3 wire null modem cable (color coded Gray, White and Blue). Connect one end of the cable to the "RS-232" header (DHE3) on the primary TBC-IV, (the one connected to the PAR card). Connect the other end of the null modem cable to the "RS-232" data connector (DHE3) on the second TBC-IV.

Check Jumper CHE4 on the first TBC-IV card (the one connected to the PAR) to ensure that they are placed in the TX "transmit" position. This is the position furthest from the edge of the card as illustrated in figure 1-2. This jumper may be unmarked on the board silk-screen so you may need to refer to figure 1-2 to locate it..

If you are installing any more TBC-IV cards (that is, a third one, or more), they can be connected as described in the section "Installing Multiple TBC Cards in the Same Computer", in the TBC IV operations manual.

Figure 1-2

Locating Jumper CHE4

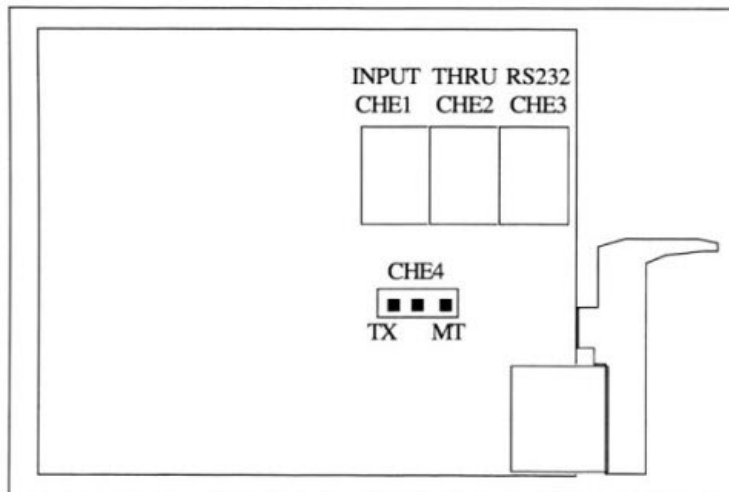

Figure 1-3

**Installing the
PAR and TBC
cards in the
AMIGA 2000**

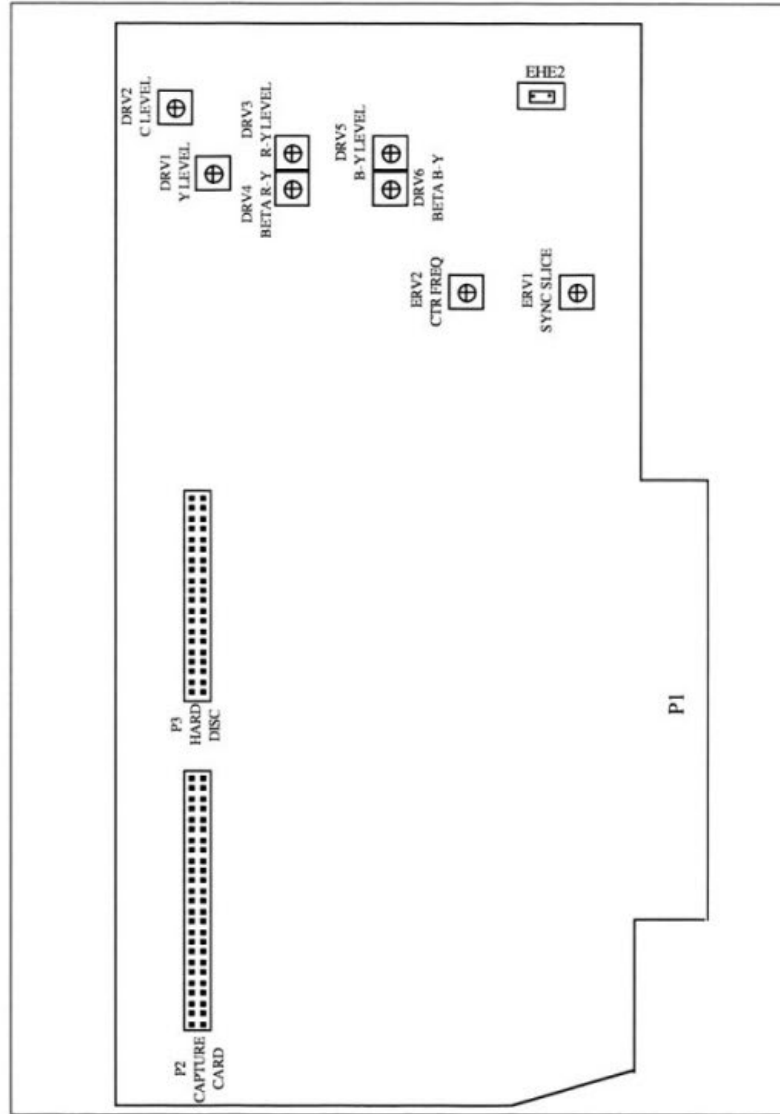

Figure 1-4

**Installing the
PAR and TBC
cards in the
AMIGA 4000**



Figure 1-5
PAR Card



CHAPTER 2

Video Connections

Figure 2-1

PAR
I/O
Connections

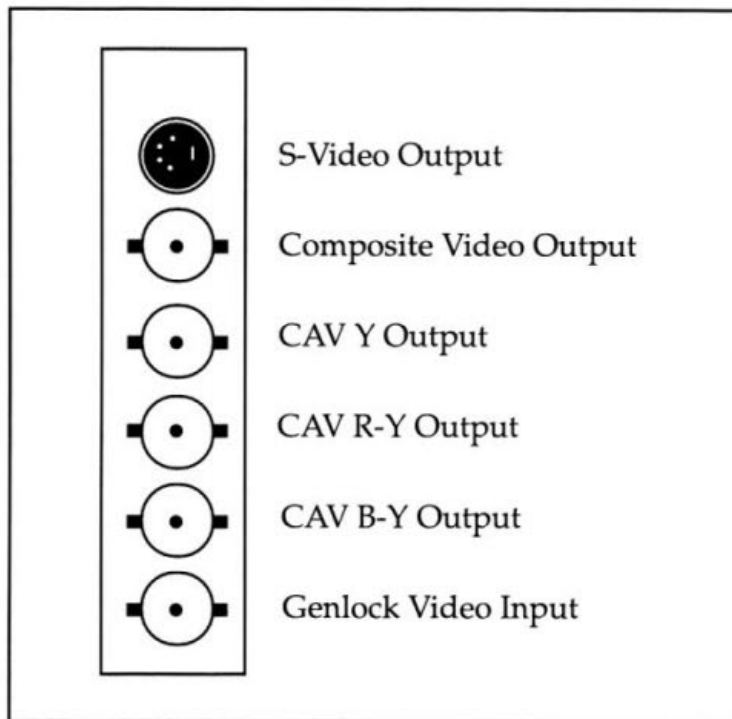

S-Video Output:

This output contains the separate Y/C 3.58MHz signal conforming to the S-Video standard. It is used to interface with other S-Video type equipment, using a standard 4-pin standard S-Video cable. Make sure that you are using quality S-Video cables.

CAV Y Output:

This output contains the Component Analog Video (CAV) Y signal for use with Betacam or MII type equipment. Remember that when hooking up Betacam or MII type equipment, you must also choose the appropriate output level from the software preferences settings (Beta/MII).

CAV R-Y Output:

This output contains the CAV R-Y signal for use with Betacam or MII type equipment.

CAV B-Y Output:

This output contains the CAV B-Y signal for use with Betacam or MII type equipment.

Genlock Video Input:

The genlock video input is used by the Personal Animation Recorder card to establish the timing for its video output signals. The signal connected to this input must always be STABLE, such as the output from a black burst or color bar generator. DO NOT attempt to use a non-time base corrected VCR for your genlock reference.

Figure 2-2

TBC-IV
I/O
Connections

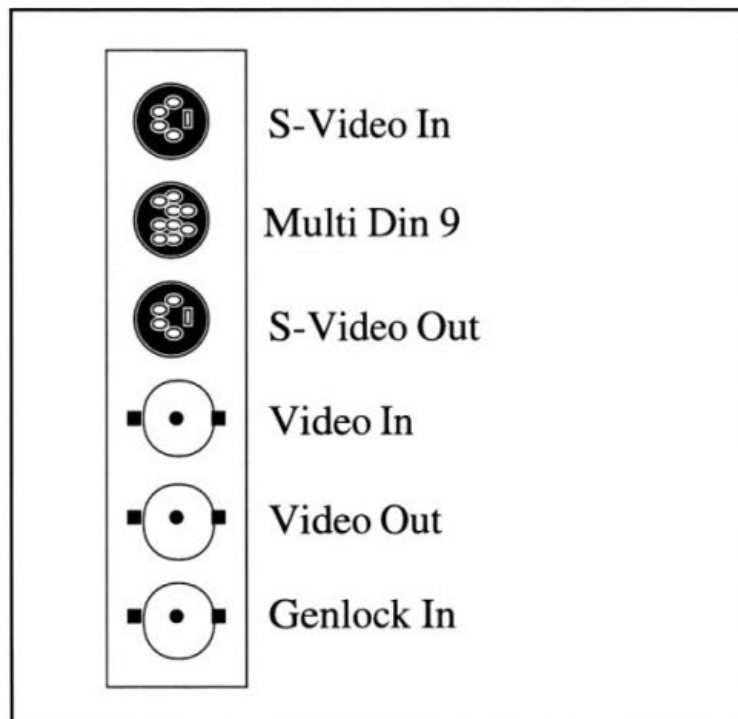

S-Video Input

This 4-pin connector is used to input S-Video (S-VHS or Hi8) to the TBC card. It is normally connected to the S-Video output of a playback VCR using a standard 4-pin to 4-pin S-Video cable. Some JVC industrial type S-VHS players use a 7-pin connector for their S-Video output. To interface with such machines, a 7-pin to 4-pin adapter cable is required.

Multi Function I/O (DIN-9)

The multi-function DIN-9 connector may be used as an advanced sync output by connecting the DPS #774-532 breakout cable, and using the advanced sync BNC. The advanced sync signal can then be fed to the EXT SYNC input of a suitably equipped playback VCR. This connector may also be used for GPI freeze by connecting the RCA connector on the breakout cable to a suitable switch. For more information on using the advanced sync or the GPI freeze please refer to the TBC-IV manual.

S-Video Output

This 4-pin connector provides the time base corrected S-Video (S-VHS or Hi8) version of the video input signal. This output is not used when the TBC-IV is configured for use with PAR.

NTSC Video Input

This BNC connector is used to feed composite NTSC video to the TBC card. It is normally connected to the video output of a playback VCR. It can also be connected to any composite NTSC source such as a TV tuner, laser disc player, camera, etc.

NTSC Video Output

This BNC connector provides a timebase corrected version of the video input signal. This output is not used when the TBC-IV is configured for use with PAR.

Genlock OK LED

This LED will light when a valid genlock video signal is connected to the TBC genlock video input.

Genlock Video Input

The genlock video input is used by the TBC card to establish the timing for its video output signal. When using the TBC-IV with the PAR, this input **MUST** be connected to the video output of the PAR board using the provided BNC "Y" cable DPS part #774-517. Refer to the following illustrations for more information.

When Using the TBC-IV with the PAR, the TBC-IV must be configured as a slave in the TBC-IV preferences requester.

Figure 2-3
PAR
Output
Connections

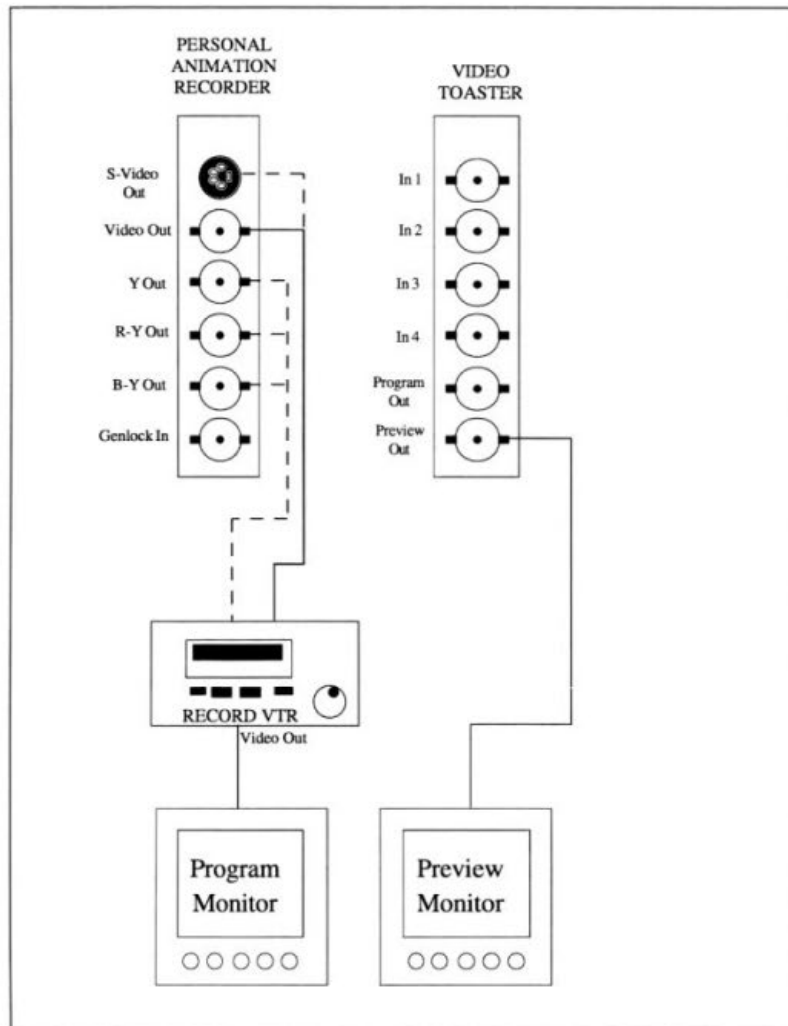

Figure 2-3 is an example of a typical installation showing how to connect the Composite Video, S-Video and CAV (Betacam or MII) outputs. Betacam and MII outputs are selected by software control. (refer to chapter four, Betacam/MII modes for more information on how to change between Betacam and MII levels).

Figure 2-4
Connecting
the PAR Card
to the Video
Toaster

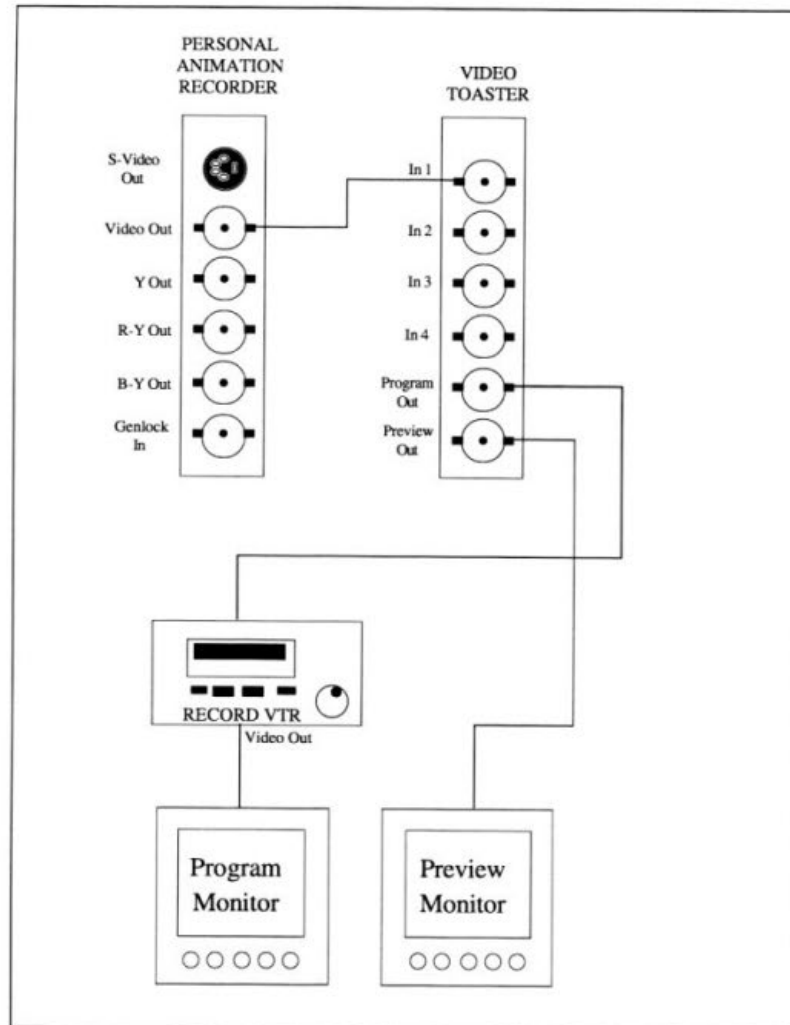
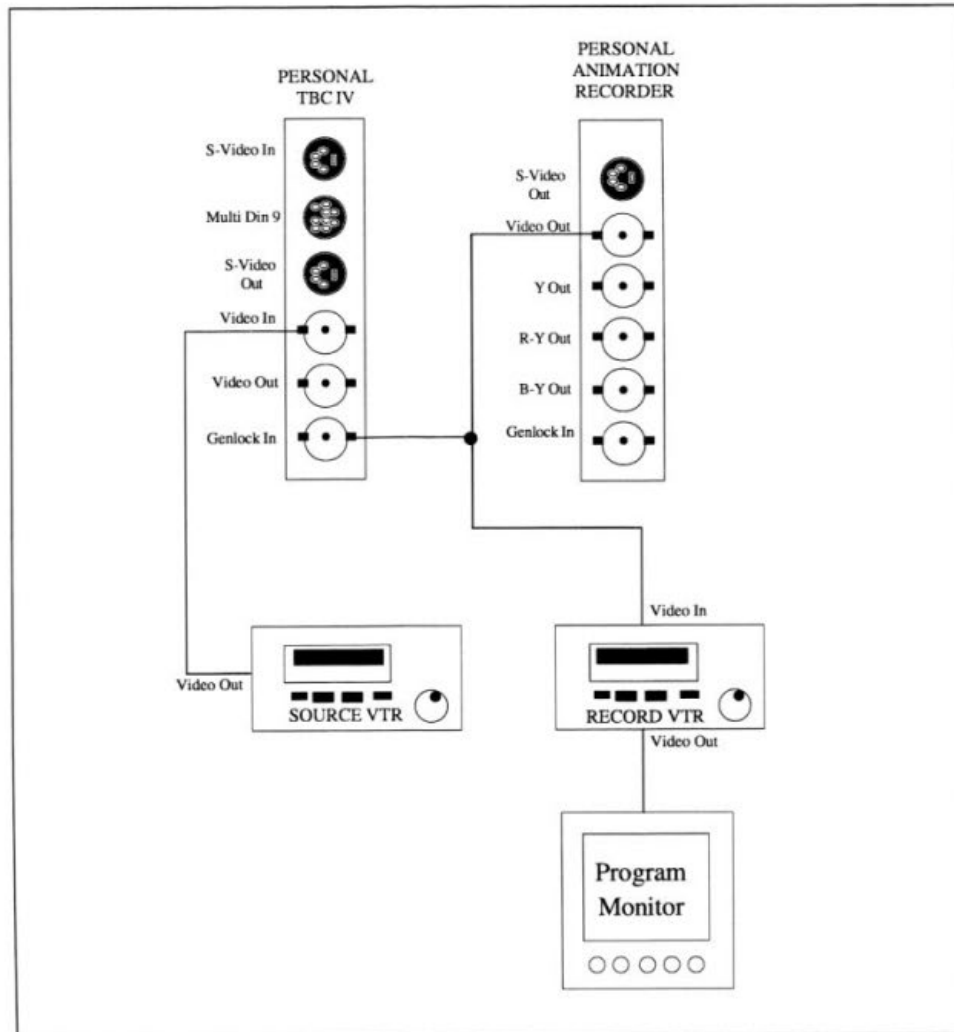

Figure 2-4 is an example of how to connect the Animation Recorder to a Video Toaster input. This procedure provides for optimum performance of the Animation Recorder and Toaster combination, since toaster effects such as superimposing text can be added to an animation.

Figure 2-5

Using the PAR Card with the Personal TBC IV



After changing the TBC genlock termination mode or the Slave/Auto modes, be sure to click on the save defaults gadget.

Figure 2-5 is an example of how to connect the PAR card to the TBC IV. The TBC IV also has an internal connection to the PAR card using the Component Video Exchange port. (CVE) This is done by connecting the CVE port (P2) on the Animation Recorder to the CVE port on the Personal TBC IV(BHE1) using the supplied 4" 50 pin ribbon cable. When installing a TBC IV card for use as a slave, the genlock input on the TBC IV must be connected to the Animation Recorder's video output. Use a BNC "T" or the provided "Y" cable if required. The TBC IV must then be configured as a slave unit in the TBC IV control software preferences screen. Be sure to click on the save defaults gadget after configuring the TBC IV as a slave.

Figure 2-6

Using a Camera for a Genlock Reference

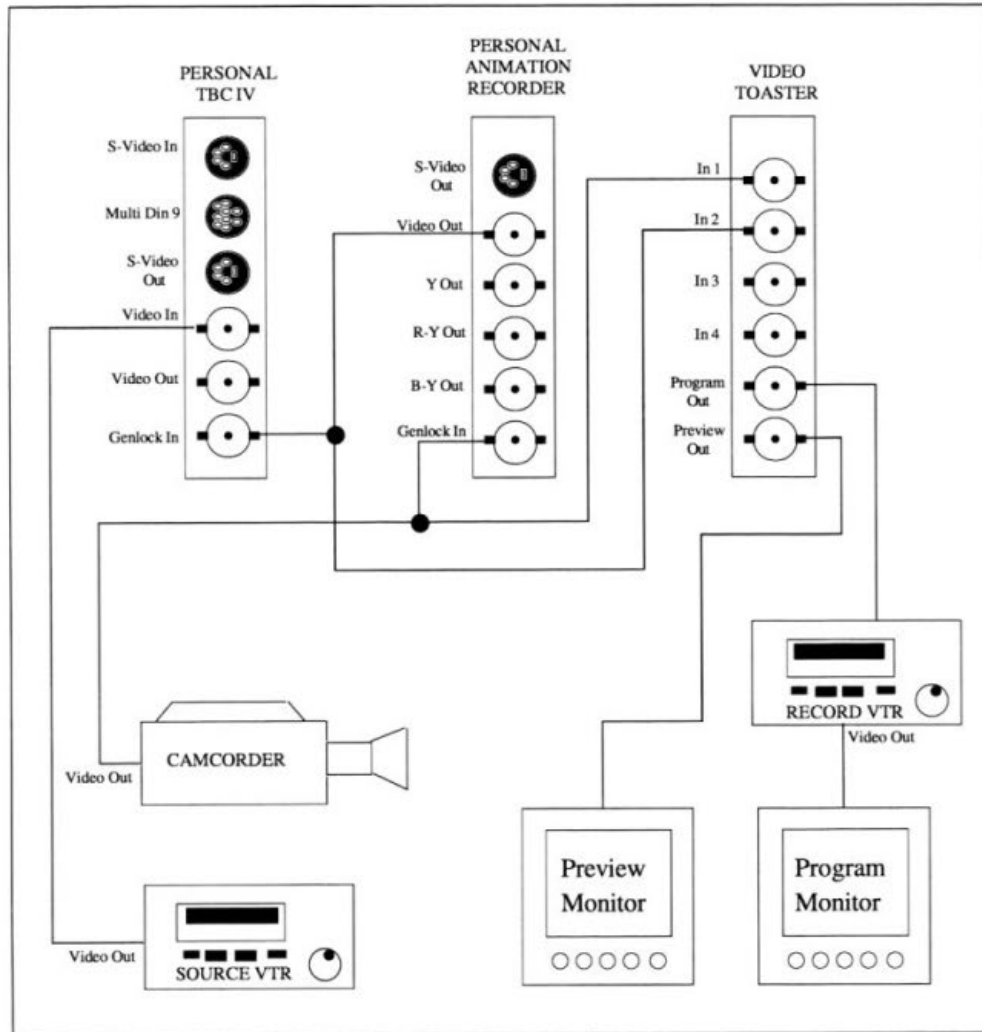

In Figure 2-6, a color camera is being used as a master genlock reference. The camera's output is connected to the Animation Recorder's genlock input and the Video Toaster's input #1. If you have selected the Toaster's input #1 to be terminated, DO NOT install the genlock termination jumper (EHE2) on the Animation Recorder card.

Figure 2-7
Using the PAR Card with Two Personal TBC III Cards

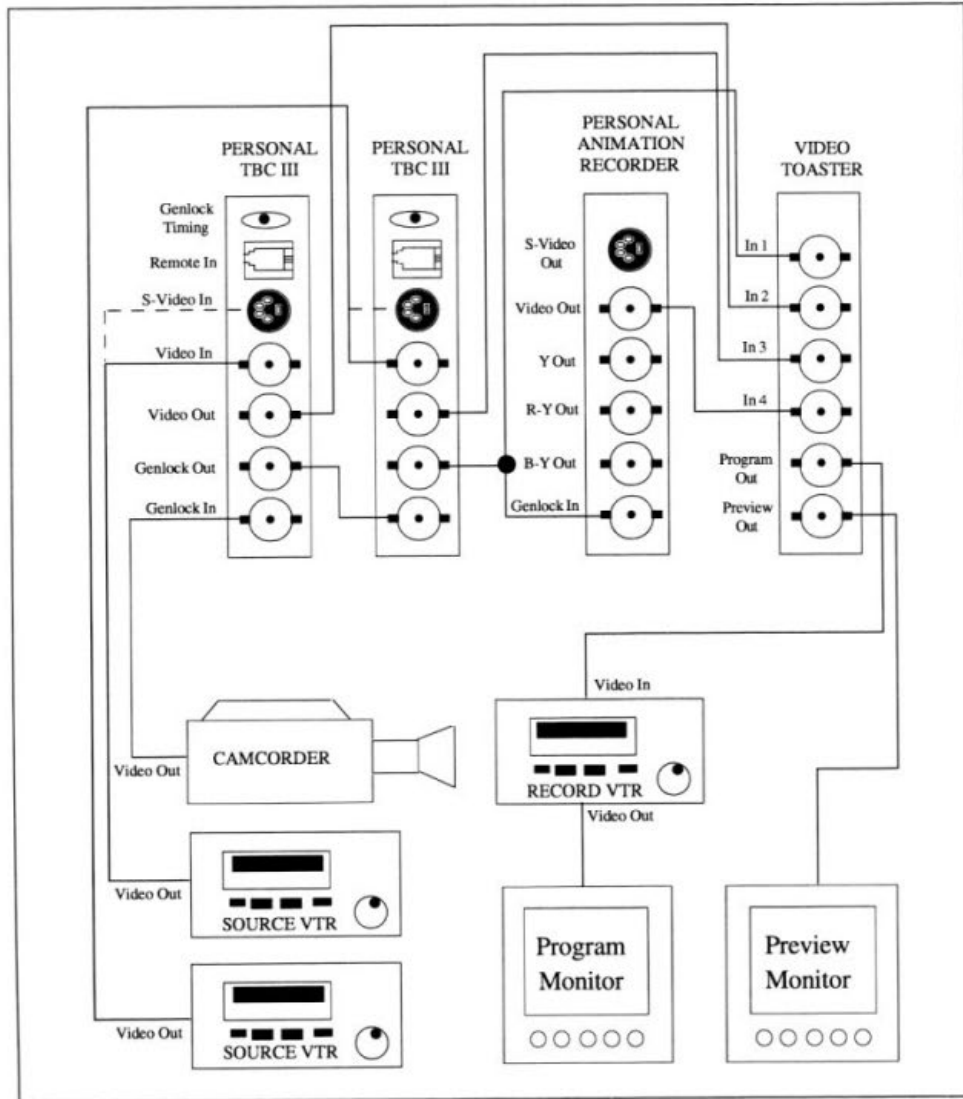

In Figure 2-7, two TBC III cards are used in the configuration. Both TBC's are in "loop through" mode as set by jumper CHE1 on the TBC III cards. Then using the supplied genlock "Y" cable, the genlock output of the second TBC card is connected to the Animation Recorder's genlock input and the Video Toaster's input #1. If you have selected the Toaster's input #1 to be terminated, DO NOT install the genlock termination jumper (EHE2) on the Animation Recorder.

Figure 2-8

Using the
PAR Card
with Betacam
or CAV
Recording
Equipment

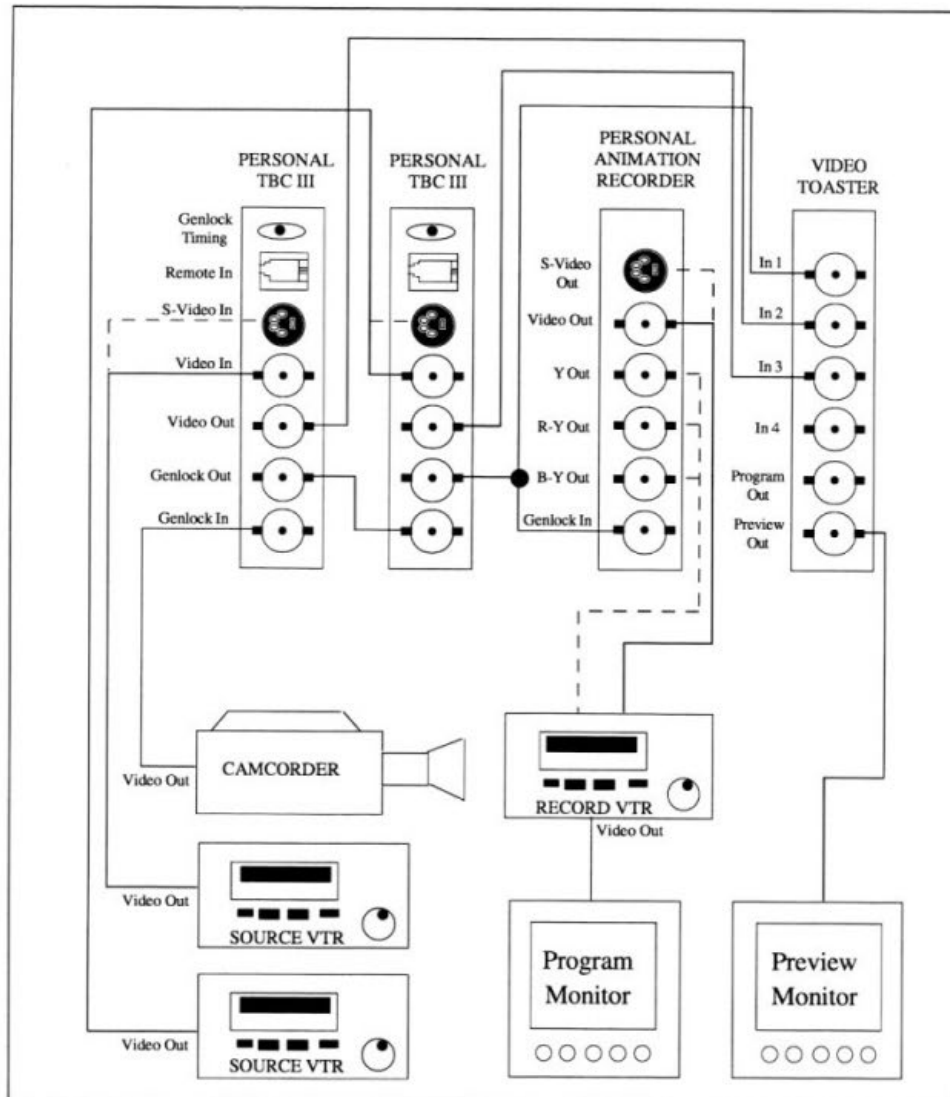

In Figure 2-7, the output of the Animation Recorder was connected to the Video Toaster's input #4. This would provide for optimum performance of the Toaster/Animation Recorder combination allowing the user to add toaster features to an animation. However, if you have S-Video or Betacam/MII recording equipment and wish to utilize their capabilities, connect your Personal Animation Recorder as shown in Figure 2-8.

Figure 2-9
Connecting a TBC IV for Video Capture with a TBC III

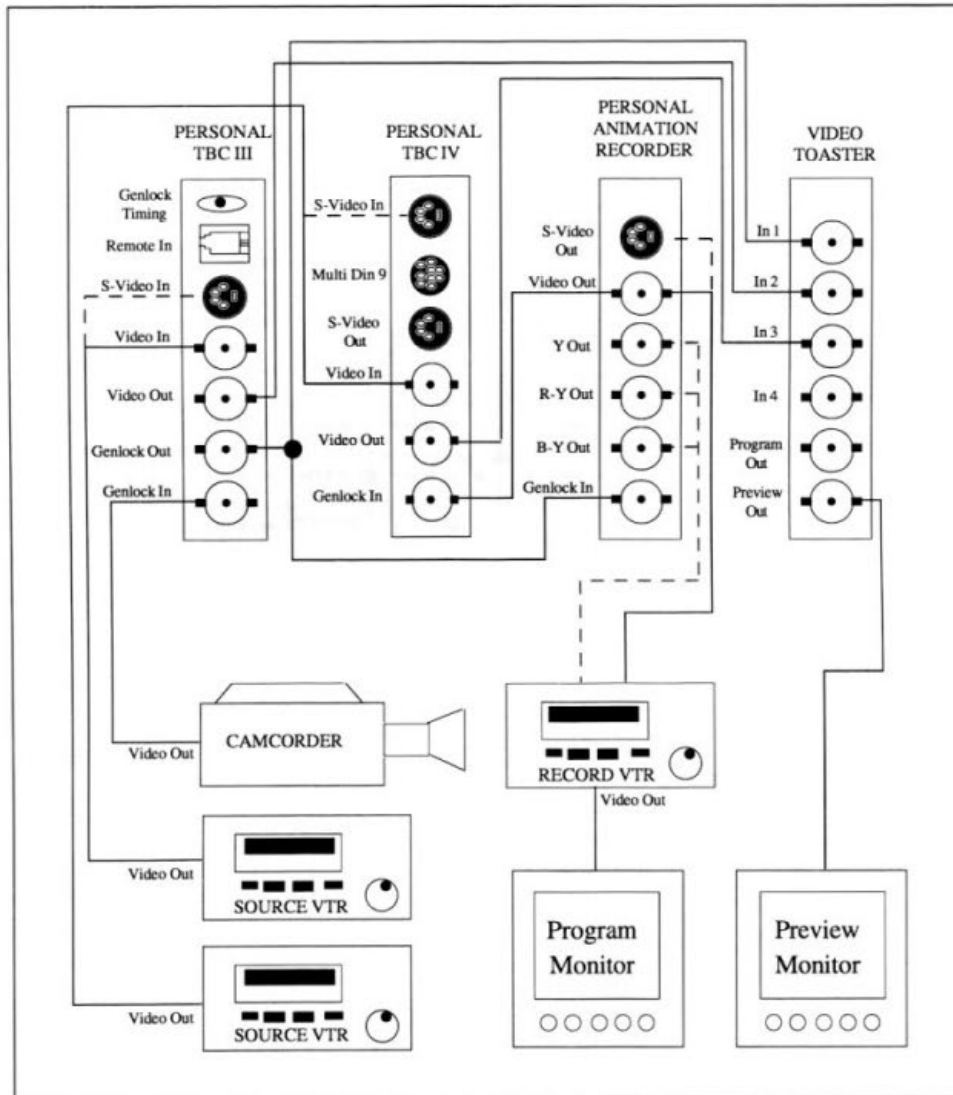

After changing the TBC genlock termination mode or the Slave/Auto modes, be sure to click on the save defaults

Figure 2-9 uses a Personal TBC III and a Personal TBC IV card. The TBC III card is connected in the usual manner. The TBC IV is internally connected to the Component Video Exchange port (CVE_) as a slave unit. This is done by connecting the CVE port (P2) on the Animation Recorder to the CVE port on the Personal TBC IV (BHE1). When installing a TBC IV card for use as a slave, the genlock input must be connected to the Animation Recorder's video output. Use a BNC "T" or the provided "Y" cable if required.

Figure 2-10

Connecting a
TBC IV for
Video Capture
with a second
TBC IV

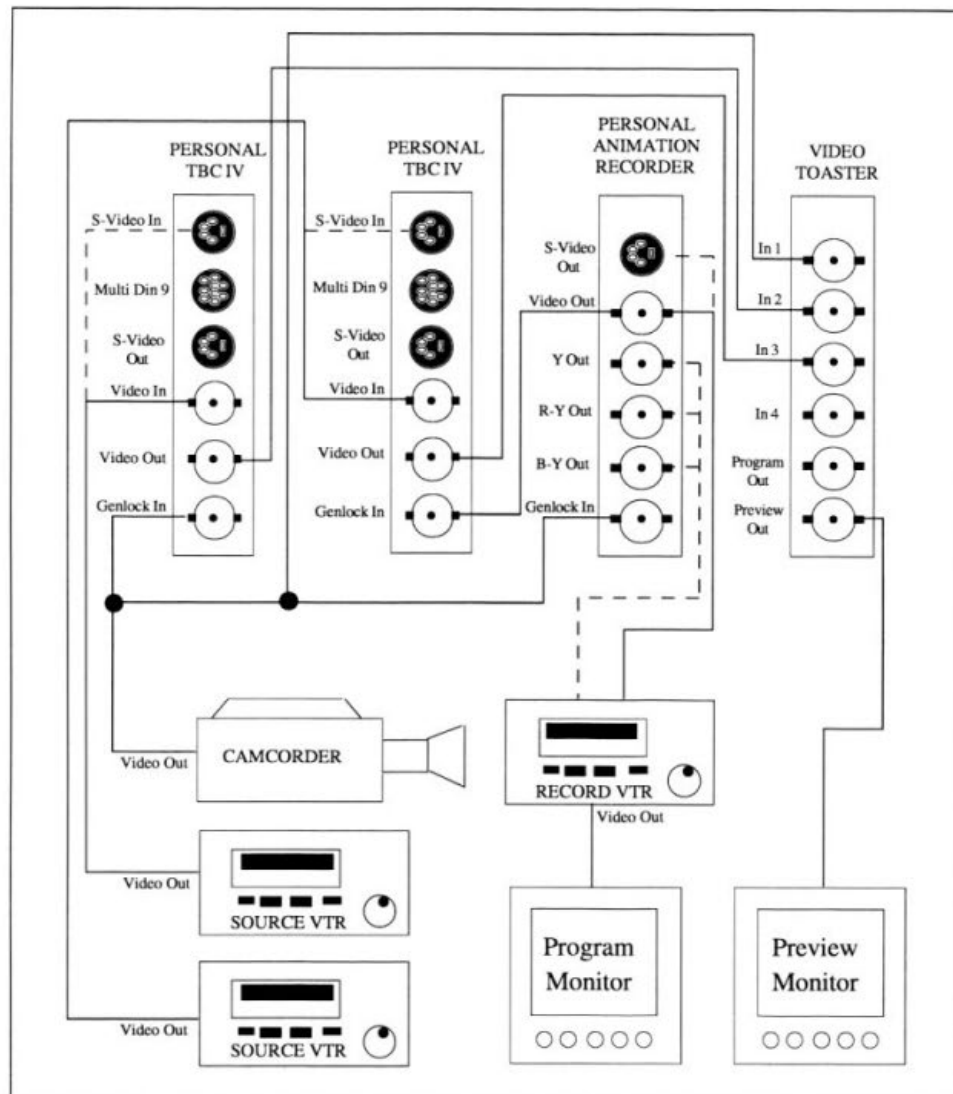

In Figure 2-10, two Personal TBC IV cards are used. The first TBC IV card is connected in the usual manner. The second TBC IV is internally connected to the Component Video Exchange port (CVE™) as a slave unit. This is done by connecting the CVE port (P2) on the Animation Recorder to the CVE port on the Personal TBC IV (BHE1). When installing a TBC IV card for use as a slave, the genlock input **MUST** be connected to the Animation Recorder's video output. Use a BNC "T" or the provided "Y" cable if required.

Intentionally
Left
Blank

CHAPTER 3

Software Installation

Installing PAR Software from the Amiga Workbench

Use this installation procedure if you have an Amiga computer without a Video Toaster, or if you do have a Toaster but you launch its software from the Amiga Workbench. If you have a Video Toaster which autoboots after power-up of the computer, go to Installing PAR Software in Autoboot Systems. Otherwise, install your PAR software with the following steps:

- Turn on your computer and go to the Amiga Workbench screen.
- Insert the supplied Personal Animation Recorder diskette in an internal Amiga floppy disk drive (usually DF0:)
- When the DPS disk icon appears on the Workbench screen, double click on it to open it.
- Double click on the INSTALL icon and follow the instructions that appear. Unless you specify otherwise, the PAR software will be installed in a new drawer called "PAR".

Don't drag files from the distribution disk to a drawer. PAR software must be installed using the installation program.

Installing PAR Software in Autoboot Toaster Systems 2.0 and lower

If your Amiga system automatically loads the Video Toaster Switcher screen at power-up, you should perform the following steps to install and run the DPS PAR software. These procedures are necessary because autoboot Toaster systems do not normally provide direct access to the Amiga Workbench screen.

- Turn on your computer and let the Toaster Switcher load normally.
- Quit the Toaster Switcher program.
- Insert the supplied DPS PAR diskette into an internal Amiga floppy disk drive (usually DF0:).

- When the DPS disk icon appears on the Workbench, double click on it to open it.
- Double click on the INSTALL icon and follow the instructions that appear. Unless you specify otherwise, the PAR software will be installed in a new drawer called "PAR". Be sure to answer YES when asked if you wish to modify the Toaster auto startup sequence to include the PAR program. If you don't, you will be required to load, quit, and reload the Video Toaster program every time you run PAR software. By permitting the PAR installation program to modify the Toaster startup sequence, the PAR program will automatically be loaded each time you boot the computer.
- When the installation program is complete, reboot your computer. The PAR control software and the Video Toaster program will load automatically. After both programs have finished loading, the Video Toaster Switcher screen will appear, and you can use it normally.

Installing PAR Software in Autoboot Toaster Systems 3.0 and higher

If your Amiga system automatically loads the Video Toaster Switcher screen at power-up, you should perform the following steps to install and run the DPS PAR software. These procedures are necessary because autoboot Toaster systems do not normally provide direct access to the Amiga Workbench screen.

- Turn on your computer and let the Toaster Switcher load normally.
- Quit the Toaster Switcher program.
- Insert the supplied DPS PAR diskette into an internal Amiga floppy disk drive (usually DF0:).
- When the DPS disk icon appears on the Workbench, double click on it to open it.

- Double click on the INSTALL icon and follow the instructions that appear. Unless you specify otherwise, the PAR software will be installed in a new drawer called "PAR". Be sure to answer NO when asked if you wish to modify the Toaster auto startup sequence to include the PAR program. When the installation program is complete open the drawer in which you installed the PAR software. Double click on the PAR icon to run the PAR software. Now select the 'Quit' button to quit the PAR software. This is required to tell the PAR software where it's home directory is. After this is done, drag the PAR icon to the Wbstartup drawer located on your system hard drive. If you don't do this you will be required to load, quit, and reload the Video Toaster program every time you run PAR software. By placing the PAR software in the Wbstartup drawer, the PAR program will automatically be loaded each time you boot the computer.
- Now reboot your computer. The PAR control software and the Video Toaster program will load automatically. After both programs have finished loading, the Video Toaster Switcher screen will appear, and you can use it normally.

Starting Up PAR Software

If you are starting PAR from Amiga Workbench, simply enter the PAR drawer (or wherever you decided to store the PAR files) and double click on the PAR icon. This will start up PAR software.

If your computer autoboots the Video Toaster Switcher, the PAR software is already running. To get to the PAR screen, you must first get to the Amiga Workbench screen. Do this by pressing the <Ctrl> key on your keyboard twice, then press the <Alt> twice, that is, <Ctrl> <Ctrl> <Alt> <Alt>. After a short wait, the Workbench screen will appear. Now click on the drawer where the PAR files were installed, and the PAR icon will appear. Double click on it, and the PAR control screen will appear.

Format the PAR Hard Disk Drive

Since this is the first time that you are running PAR software, and you are using a new hard disk drive, the hard disk drive must be formatted. To do this, select the 'Prefs' button from the main screen, and then select the 'Format Disk' button (see Figure 4-1). PAR will display a confirmation requester, asking you to confirm. Click on Yes, and the formatting process will begin.

This formatting operation affects only the PAR dedicated hard drive, and will not affect any of the AmigaDOS drives (such as DH0, DF0, DF1, etc.). Rest assured that the data on your Amiga drives will not be erased!

Formatting the drive may take anywhere from a few seconds to several minutes. You should not have to format your PAR disk again, unless the file directory should somehow become corrupted.

PAR hard disk

The PAR hard disk is an extremely high performance device and when handled properly it can last for many years. By taking a few precautions you can insure that you will get the full performance and life out of your hard disk. The number one cause of hard disk failure is heat. Make sure that your drive is receiving proper cooling. Most computer cases are not designed to insure adequate ventilation and you may have to add a supplementary fan to help keep your drive cool. A general rule of thumb is that if your drive is more than warm to the touch, it is probably too hot. If your PAR hard disk is getting hot, shut down your computer until there is adequate cooling for your drive. Your local dealer should be able to help you find a small fan or fan card for your computer. **CONTINUED USE OF THE HARD DISK WHEN IT IS HOT WILL CAUSE DAMAGE TO THE DRIVE!**

Because the PAR hard disk becomes such an integral part of your system, it is very tempting to over use your drive. You can load the drive up with animations and still frames until the drive is full, but you will not be making the most efficient use of your drive. The most efficient way to use the disk is to treat it as though it were another tape machine. Only use it to store the current animation(s) or still(s) that you are working on and keep all of your work backed up to a system hard disk or tape device.

After you've begun using PAR for capturing animations and stills, you'll want to do regular backups of data on the PAR dedicated hard disk drive, just as you do for your Amiga disk. Also, you may want to do backups just to make more space on the PAR hard disk, since one or two big animations could fill it up.

Because the data on the PAR disk is accessible from the Amiga operating system (just as if they were on the Amiga disk), you can use the same backup tools that you already use. Obviously, a tape backup is the only practical system because of the large size of the PAR disk drive. We recommend AmiBack or Quarterback archival software systems. Make sure that you set the export mode of the PAR to PAR files and deselect 'Translate' before attempting to back up the PAR hard disk.

Quitting From PAR Software

If you need to shut down PAR software for any reason (such as to free up some of your computer's memory), simply click on the 'Quit' button at the right hand side, about half-way up the screen.

Setting Up Communication to the TBC IV via the PAR Card

If you have installed the TBC-IV with a DPS Personal Animation Recorder card, you will probably want to control the TBC-IV "through" the PAR card, rather than via the Amiga's serial port connector. To do this, you'll need to connect the CVE cable between the TBC-IV and the PAR cards, as described in the installation section of this manual.

In addition, you'll have to configure the TBC-IV program to "talk" to the PAR card. To do this, use the following procedure:

For TBC-IV software version 2.5 and above

- Select the 'Prefs' button.
- In the Prefs window there will be either a 'Serial' or 'PAR' button. Click this button until it reads 'PAR'. The baud rate will automatically change to '9600'.
- Quit the TBC-IV program, the new settings will now be saved so that the next time the program is run they will be set to "talk" to the PAR card.

For TBC-IV software versions 2.5 and below

- Quit the TBC-IV program so that the Amiga Workbench screen is showing.
- Select the window that contains the TBC-IV icon, and locate the TBC-IV icon on the Workbench screen.
- Click on the icon so that it becomes highlighted.
- Press and hold the right mouse button to make the Workbench commands appear at the top bar then, drag down the "Icons" item, and then select the "Information" item within that menu.
- At the tool types area of the info screen, use the scroll gadget to select the "DEVICE=serial.device" tool type. When you click on it, it will appear in the editing box just below the Tool Types requester. Edit it to read "DEVICE=PAR", making sure that you use upper case letters. Press the return key on the keyboard. Then select the "BAUD" tool, and edit it to read "BAUD=9600". Press the return key on the keyboard.
- Click on the 'Save' button. You can now restart the TBC-IV software by double clicking on its icon. The controls should now be fully operational.

CHAPTER 4

The PAR Project Manager Screen

The PAR User Interface

PAR provides a user interface which is consistent with many other Amiga application programs. You've probably already been using your Amiga with other software, such as LightWave, Morph Plus or TBC-IV, so you should be familiar with the basic concepts of screens, windows, and the various types of gadgets.

Screen Layout

The PAR control screen, as shown in Figure 4-1, is divided into four main areas:

- The File Management windows and requester
- The PAR Recorder/Playback Deck (or PAR Deck, for short)
- The File Compression Control gadgets
- The System Control gadgets

Figure 4-1

PAR
Control
Screen

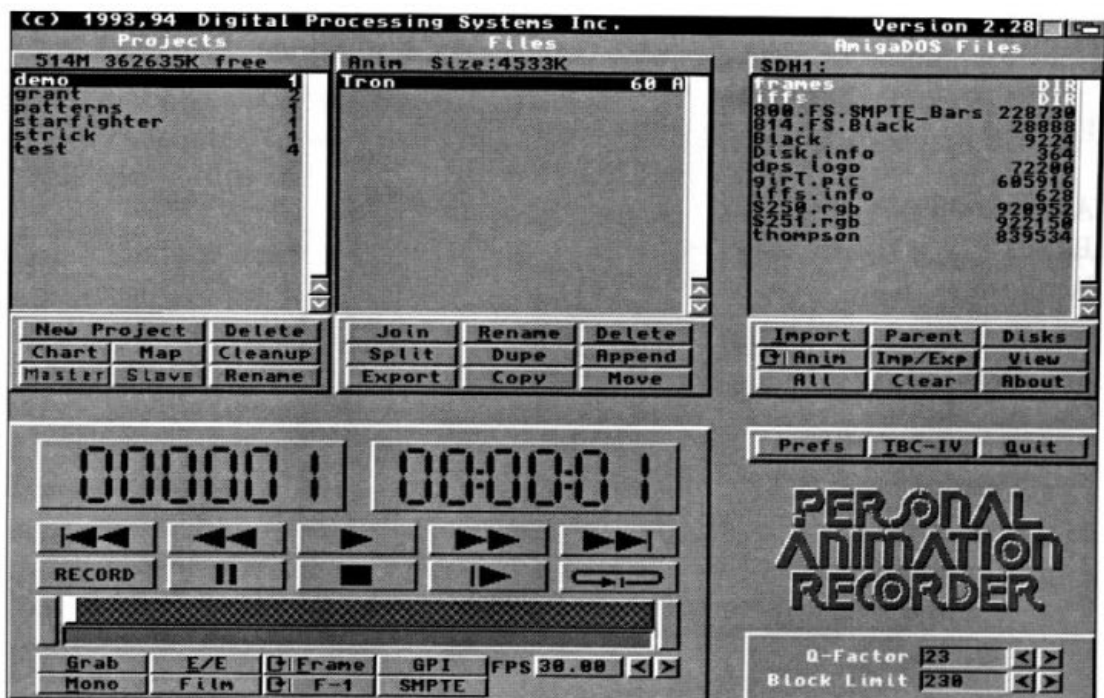

The File Management Windows and Requesters

The File Management area is divided into two sections, (as shown in Figure 4-1). The window to the right, labeled "AmigaDOS Files", displays filenames from the Amiga disk drives, while the two windows on the left are used to see Projects and Files in the dedicated PAR hard drive.

The AmigaDOS Files Requester

From this requester (as shown in Figure 4-2), you can select files to be converted into PAR animations and stills; you can also select directories into which PAR sends IFF format files. You'll have to use this file requester if you want to:

- Render your animations to IFF files before copying to the PAR. Normally, you will record your animation frames directly to the PAR, bypassing the Amiga disk drive.
- Use PAR as a high-capacity, rapid-access still store.
- Use PAR to capture real-time video or stills, then transfer your animation to other programs for rotoscoping or special effects.

Figure 4-2
AmigaDOS
Files
Requester

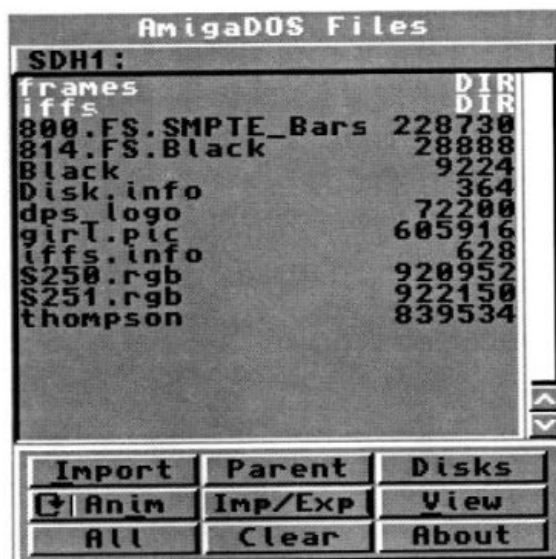

The AmigaDOS Files requester displays a list of files and subdirectories (drawers), in the same format as any Amiga file requester. The scroll bar and arrows at the right of the window are used to adjust the position of the view, if the list of files is longer than the window.

At the bottom of the AmigaDOS Files requester are 9 buttons/gadgets that are used to manipulate the selection of image files on the Amiga disk drives, as well as the conversion of image files into and out of the PAR hard drive.

Note: The AmigaDOS Files requester in PAR cannot be used for other file management functions, such as deleting files, or copying them within the Amiga disk drive.

Navigating Through AmigaDOS Devices and Subdirectories

Two of the buttons in the AmigaDOS Files requester are used to navigate through the Amiga's logical and physical disk drives, in order to specify files to be accessed by PAR:

Disks:

When the 'Disks' button is selected, the file requester window will display a list of all available disk partitions (VOL), assigned devices (ASN) and physical devices (DEV). Clicking on any item in this list causes the file requester to move into that logical device, and display a list of files and subdirectories (drawers) and files there.

Once a device has been selected, clicking on any subdirectory (indicated by DIR in the right-hand column) will cause the file requester to move into that subdirectory. Subdirectories and devices are displayed in white text, while filenames are displayed (along with the file size in bytes) in black.

Parent:

Select the 'Parent' button to move from a subdirectory up into its parent directory. If the file requester is already in the root directory, then selecting this button will have no effect.

Selecting Image Files to be Copied and Converted by PAR

Once you've set the AmigaDOS Files requester to the subdirectory where your image files are, simply click on each file that you wish to copy into PAR. The filename will be highlighted (displayed as white letters on a black bar) to let you see which files in the directory have already been selected.

Clicking again on a selected file will clear or "de-select it". Whenever you leave a directory, all selected files will be cleared (de-selected)

View:

If you just want to have a look at the image in a selected file, simply select the 'View' button. In a few seconds, the image will be displayed at the video output of the PAR card. Bear in mind that if more than one file is selected, the View function will only act upon the selected file nearest the top of the list.

Two of the buttons at the bottom of the file requester will help you in selecting files:

All:

Selecting this button will select all files in the current directory. Be careful with this, since it will even select files which are not compatible image files.

Clear:

Selecting this button causes all selected files in the directory to be "de-selected." If you're in a big directory and you're about to select an individual file to copy into PAR, it's a good idea to hit the 'Clear' button first, just in case there were any selected files above or below the window view.

The remaining buttons in the AmigaDOS Files requester are described briefly below. You'll find more comprehensive explanation of their functions in the sections of this manual that deal with specific uses of the Personal Animation Recorder.

Import:

This button causes files selected in the AmigaDOS Files selector to be copied from the Amiga disk drive, compressed, then written onto the PAR dedicated hard drive. Selecting the 'Import' button of the Amiga File directory will bring up a set of animation builder controls. These controls allow you to control how the PAR handles the way it looks at the file numbers before it brings each file into the PAR.

Increment:

Increment allows you to control the number that the PAR adds to the previous frame number in order to calculate the next frame. For instance, normally the PAR would add '1' to the previous frame so that the next frame would be one frame greater than the previous frame. Boat.0001, Boat.0002, Boat.0003, etc.. Setting the 'Increment' number to any number other than '1' will cause the PAR to add that number to the previous frame. For instance setting the increment number to '2' will cause the PAR to import every other frame. Boat.0001, Boat.0003, Boat.0005, etc..

This is used to control the effective playback speed of an animation and to make quick previews. You could create a quick preview of the animation you are working on by importing only every other frame. This would of course result in a your animation playing back twice as fast, so to restore normal 30 FPS timing, refer to the documentation regarding 'Multiply'.

Multiply:

Multiply allows you to control the number of times each frame is imported. Normally the PAR imports each frame '1' time. Setting the Multiply control to any other number causes the PAR to import each frame 'x' number of times. Setting it to '2' would cause the Boat frames to be imported as Boat.0001, Boat.0001, Boat.0002, Boat.0002, Boat.0003, Boat.0003, etc.. Multiply only does one true import per frame, and then it writes the frame 'x' number of times out of its local memory so there is very little penalty in terms of time for doing a multiple import.

PAR is compatible with image files in IFF, Targa, SGI, YUV (proprietary) , PAR and Video Toaster Framestore format. If you attempt to copy files in any other format, an error message will be displayed, indicating that the file is an unsupported file format.

After you click on the 'Import' button, PAR will take from one to six seconds to copy and convert each selected image onto its hard drive. During this time, the video output from PAR will be blanked.

Anim/Still:

Clicking on this cycle gadget lets you select between Animation and Still modes. It controls the type of file that PAR creates (either "A" or "S" type files) to store the images that you are copying from the Amiga disk drive. Although "A" type files can be split into separate "S" files, an "S" file cannot be turned into (or inserted into) an "A" file. If you are using PAR as an animation recorder, keep this set to Anim, and if you are using PAR as a still store, set it to Still.

Imp/Exp:

Click on this button to bring up the Import/Export control window. From this window Translate can be turned on, which will allow programs such as LightWave or ADPro to extract single frames from a PAR animation file. Frame/Field mode can be selected, allowing a full frame, field 1, field 2, or both field 1&2 to be exported. Field Double can be turned on, giving a full frame from a single field, but at half the vertical resolution. Export file type can be specified, clicking on this cycle gadget will cycle through the different file formats.

Figure 4-3

Import/
Export
Control
Window

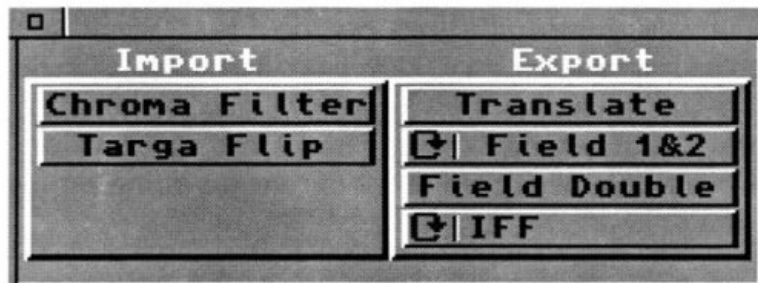

Translate:

Translate forces other programs to see PAR animation files as if they are sequences of images instead of single animations. This means that any program that can load IFF files, can now load images directly out of PAR animations without having to use ARexx or pre-export the files. This makes using the PAR for rotoscoping extremely efficient and easy to use. For instance if you wanted to use a picture viewing program to display PAR images on your computer monitor you just have to set the Export mode to 'Translate', then set the file type to any of the export types (IFF, SGI, PAR, TARGA, etc.). Then from your image viewing software, select the PAR animation and the frame offset of the desired image. For instance, if you want to have an animation called 'Boat' and you want to display frame 200, then from the file requester of the image viewer, select 'Boat' and edit the file name so that it has the frame offset appended. For frame 200, we would select 'Boat' and add .0200 to the end so the filename would become 'Boat.0200'. The PAR will automatically 'Translate' the request for the non existent filename and export the proper frame to your image viewer.

The real power of the 'Translate' function is to allow the PAR to be a source of multiple image streams for use in rotoscoping and compositing software.

LightWave 3D

To use the PAR as a source of one or more video streams for use in LightWave 3D as animated texture maps (Rotoscoping), you would use the following method:

Note:

The image will not load on an F9. Images will not show up in preview until after the first frame is rendered.

- Select 'Translate' from the export buttons.
- Select 'IFF' for the export file type.
- From LightWave, under 'Images' choose 'Image Sequence'.
- Using the previous example, choose the animation you would like to use as the source, we would choose 'Boat' on the PAR hard drive and append the starting frame number to the end of the file name.
- Repeat steps 3 and 4 for all the image sequences that you would like to import.

From that point on, you can use the image sequences in place of any texture map in LightWave 3D. This method should work for any software that allows you to specify a starting frame and that it will be loading a sequence of images.

Note: Any software that attempts to physically scan the directory for all the images will not work. Some batch rendering software works this way, expecting all files to be available at once and since the PAR translates the files on the fly, only one file will appear in the directory at any one time.

Field Handling

This button will allow you to choose which form of 'field' handling you use for exporting. In short, each file consists of two fields, with each field consisting of either all the even numbered horizontal lines, or all the odd numbered horizontal lines. So for any given 'Frame' (two fields) or image, all the odd lines starting at line 1 are one field, and all the even lines starting at line 2 make up the other field. This is the same way your television works.

If you choose any mode other than frame, you will only export one half of the image data. Choosing field 1 for instance would export your files as 752 pixels wide, but only 240 pixels tall because you are only exporting one field of data (every other line). To export full size images, See 'Field Double'.

Frame:

'Frame' will cause the entire image to be exported

Field 1:

'Field 1' will cause only the first field to be exported.

Field 2:

'Field 2' will cause only the second field to be exported.

Field 1&2:

'Field 1&2' will cause both fields to be exported, but as two separate files.

For instance in our 'Boat' animation, with this button selected, we would be exporting 'Boat.0001' and 'Boat.0002', with each file only containing one field of information.

Field Double:

Field Double when used in combination with any of the previous single field modes will cause each field to be exported 'doubled'. Each line in the image will be doubled so that the exported image is the normal image height of 480 lines. Field Double is used most often to remove motion artifacting from the image data. For instance, if you were to record live video using the TBC-IV, and then step through each image one frame at a time, you would see some motion in each frame, this is known as 'motion artifacting'. The problem with using 'Field' modes in combination with 'Field Double' is that you lose one half of the effective vertical resolution. For most rotoscoping applications, this loss of resolution is negligible.

Export File Format

This button allows you to choose how the PAR copies files back to the system drive. The available modes are SGI, IFF, YUV (proprietary), TARGA, and PAR. This is the same effective set of controls that you will find in the controls of the 'Export' button under the PAR files directory.

SGI:

When 'SGI' is selected the file will be exported in a file format compatible with Silicon Graphics systems.

IFF:

'IFF' is the standard Amiga file format. In this mode the files will be compatible with programs such as LightWave for use in rotoscoping.

YUV:

This mode is proprietary and is not recognizable by standard YUV loaders. YUV is useful for AReXX scripts which copy files from the PAR to the Amiga and back to the PAR but are not going through any external processing. (You cannot use it with an external image processing program) For instance, if you had accidentally rendered your entire animation at too high of a Block Limit setting, you can write a script to export each frame, and import it back into a new

animation at a lower Block Limit value. The YUV importer is extremely fast and efficient, and is in fact virtually lossless, so your animation will not lose any quality in the export/re-import process.

TARGA:

'TARGA' is a standard file format used in the PC compatible environment.

PAR:

'PAR' format is the PAR's internal file format. The files will be exported retaining all attributes, including Q-Factor, and Block Limit. These files can be re-imported without loss of quality.

NOTE: There are no controls for file importing as the PAR automatically recognizes the type of file that it is trying to import or view.

Chroma filter:

PAR provides a video Chroma filter because animation and still frames that have been computer generated may have very high color bandwidth. So high, in fact, that they exceed the capability of other equipment that will be used to process the image (such as your VCR or monitor), and a very unpleasant picture results. (Toaster Framestore images do not have this problem, since they are pre-filtered; PAR automatically disables the filter when converting Framestores). The filter prevents these problems from occurring, although in most pictures, the effect of the filter is not perceptible. We recommend that you leave the Filter on at all times.

Targa Flip:

If you are loading animation frames that were rendered on a PC, you may encounter files which have the fields reversed. This usually only happens with Targa files rendered in 3D Studio. Selecting 'Targa Flip' will cause all the frames to be imported with reverse fields, this only works with TARGA images.

The PAR Projects and File Requesters

Figure 4-4

PAR
Projects
and
Files
Requester



The upper left-hand area of the PAR control screen are the PAR Project and File Requesters. The Projects file requester displays names of the project subdirectories on the PAR dedicated hard drive, while the Files requester displays names and information regarding the individual still and animation files in each project.

PAR Projects Requester

All image files on the PAR hard drive must be organized into projects, which are essentially subdirectories. Therefore, before any work can begin on the PAR hard disk, a project must be defined. You may not create any still or animation files in the "root" directory, and sub-directories within projects are not allowed.

The requester window displays a list of all defined projects, with the number of files in each project shown in the right-hand column. If the project list is longer than the window, the scroll bar and arrows may be used to display other parts of the list.

PAR allows a maximum of 256 projects.

The PAR disk drive capacity (in megabytes) is shown at the top of the Projects window, at the left-hand side. To the right of this number, the unused capacity (in kilobytes) is displayed.

PAR Projects Requester Buttons

The following buttons are associated with the Projects File requester:

New Project:

This button allows you to define new projects. When you click on this button, a requester appears to ask for the name of the new project, which may be up to 17 characters in length. After typing in the new project name, press the return key on the keyboard, or click on "OK" in the requester.

Note: Although PAR will accept embedded spaces in the file name, we recommend that you do not use them, since they may not be compatible with AmigaDOS operations on these directories

Delete:

This button deletes existing projects from the PAR disk drive, including any image files in that project. When this button is selected, you will be asked to confirm that you really want to delete the project and its files. If you don't want to delete at this stage, click on Cancel, or press Esc on your keyboard.

Make sure you don't accidentally click on the 'Delete Projects' button when you want to delete files.

Chart:

Chart allows you to get a graphical display of the size of each frame in the animation. (Number of blocks used per frame). This will allow you to see how efficiently your animation is being saved and to get some idea of how each frame is handled by the PAR. If you are doing live recording, you can get some feeling for which frames are near the block limit, and if it would be possible to re-record the sequence at a higher/lower block level.

Map:

When you choose 'Map', the program charts the space on the disk that each file is using, starting at the left hand side, and filling up the screen towards the left. The area on the far right is the map of the still images on the drive. The currently selected file on the PAR files menu will show up as a highlighted section. Ideally you should have an unbroken 'map' from the left hand side of the screen to the last file. This would indicate that your disk is optimized and being utilized efficiently. Blank spaces in the map indicate areas of the drive that are not being utilized. If you see a large portion of the map that is blank or many smaller areas, then the drive is fragmented and needs to be optimized.

Cleanup:

Data on the PAR hard drive must be very well organized in order to achieve the best quality of animation playback. Normally, as files are added to various projects, PAR software manages the optimum organization of data on the hard drive. However, deleting files and projects may leave unused areas on the drive which may be better utilized. The 'Cleanup' button initiates a reorganization of stored data to accomplish this, although you will not see any change in the projects or files shown in the requester windows.

Master/Slave:

If your system is configured with a master and a slave drives dedicated to PAR, these buttons will select between the master and slave PAR drives. If your configuration consists of a master drive only, this feature will be disabled.

Rename:

Click on this button to rename a project.

PAR Files Requester

This file requester window displays the names of still and animation files within the currently selected project. If the file list is longer than the window, the scroll bar and arrows at the right may be used to display other parts of the list. Files are selected by clicking on them. Only one file can be selected at a time.

PAR allows a maximum of 2048 files per project. Note: although each still image is a file, an animation (regardless of the number of frames it contains), is also treated as a single file.

When entering new file names (when prompted by various PAR requesters) you may discover that PAR will accept embedded spaces. We recommend that you don't include spaces in your file names, as they may be incompatible with AmigaDOS operations.

Still Files:

Still files are indicated by the letter "S" in the right hand column of the requester. Also, when a still file is selected (by clicking on it) the word "Still" is shown at the top bar of the window.

When a still file is selected, its video image is immediately sent to the video outputs of the PAR card.

To the right of the still file filename is a number indicating the file size in Kilobytes. Also, at the top bar of the File window, the sizes of the individual fields (F1 and F2) within the selected still frame are indicated (remember that a video frame is composed of two interlaced fields).

At the right of the top bar is an indicator showing the Q-Factor that was originally used to convert this still into the PAR. This number may range from 0 to 23. For more information on Q-Factors, refer to Chapter 5.

Note that the individual frame sizes at the top bar are shown in disk blocks, which are 512 bytes each.

Animation Files:

Animation files are indicated by the letter "A" in the right hand column of the requester. Also, when an animation file is selected (by clicking on it) the word "Anim" is shown at the top bar of the window.

When an animation file is selected, its first frame is sent to the video outputs of the PAR card.

To the right of each animation file filename is a number indicating the number of image frames in the file. Therefore, an indication of 300 frames would be 10 seconds of animation at normal playback speed.

At the center of the top bar, the size (in Kilobytes) of the selected animation file is displayed. However, there is no indication of Q-Factor, as there is for still frames. This is because the Q-Factor of each frame in an animation is adjusted by PAR to ensure that it does not result in excessive block sizes, which would then result in a playback crash. For more information on Q-Factors and Block Limits, refer to the section on file compression control later in this chapter.

PAR Files Requester Buttons

The following buttons are associated with the Files requester:

Rename:

Changes the name of a file without altering its contents. Select the desired file by clicking on it, then click on this button and PAR will prompt you for a new file name; the requester begins by displaying the current file name. This function operates on both animation and still files.

Delete

Still Files:

This button deletes still files from the Files list. Select the desired file by clicking on it, then click on the 'Delete' button. PAR will warn you that you are about to delete this file, and ask for a confirmation by clicking on "OK", pressing Enter or "O" on your keyboard.

Animation Files:

This button deletes either a) entire animations, or b) individual frames within an animation file. After selecting the desired animation file, click on the 'Delete' button. PAR will ask whether you want to delete the file, or just frames (or cancel the operation).

- a) If you want to delete the entire file, click on Files, and the operation will be completed immediately (there are no further warnings).
- b) If you only want to delete specific frames, click on the 'Frames' button, and PAR will display another requester asking you what range of frames should be deleted. PAR will delete all frames from the Start frame number to the End frame number, inclusive. For example, if Start=4 and End=6, the operation will delete frames 4, 5 and 6. If you want to delete multiple frames that are not in a contiguous range, you must use this operation again.

Dup:

Still Files:

Creates a duplicate of the selected still file. Click on this button and PAR will bring up a requester asking you to enter a filename for the copied still file, with the current name as a default.

Figure 4-5

Duplicate
Frames
Requester

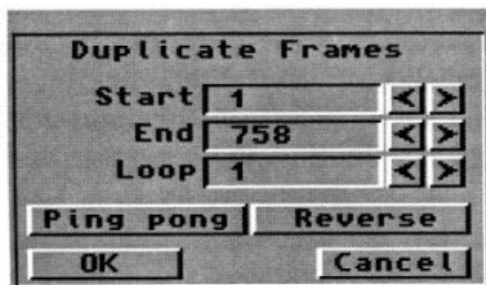

Animation Files:

You may copy a) the entire animation, b) part of the animation, or c) individual frame as a still file.

- a) To copy an entire selected animation file, click on the 'Dup' button. A requester will appear, asking whether you want to "Create a still, or select frames?". Click on Frames. The Duplicate Frames requester will appear, as shown in figure 4-4. Make sure the Start value is set to 1, and the End value is set to the number of frames in the animation. You may use the arrow buttons, or enter the value in from the keyboard (remember to hit the Enter key).

From here you have a few options. You may choose to duplicate the animation more than once in the new file, by setting the Loop gadget to a value from 2 to 100. PAR will repeat the original animation however many times you have selected using the Loop setting, with each repeat beginning seamlessly after the previous one.

Another option is to reverse the duplicate, using the 'Reverse' button in the Duplicate Frames requester. This causes the duplicated animation to be created in reverse sequence from the original, causing all motion to appear backwards. The reverse function can be applied with the Loop gadget set to any value. The reverse function can't be used with field rendering.

A third option, when making multiple duplicates, is to use the Ping-Pong feature. This causes every other duplicate of the animation to be copied in reverse sequence. This creates a "back-and-forth" appearance to any motion in the animation. For example, if you start with an animation of a hammer being brought down to hit a nail, and do a duplicate with Loop set to 5 and Ping-Pong enabled, the result will be an animation of the hammer hitting the nail three times.

Note that the Ping-Pong option has no effect if the Loop gadget is set to 1. Also, Ping-Pong and Reverse cannot be used together.

- b) To copy a portion of an animation file, perform the same operation as in (a) above, but with the following change: in the Duplicate Frames requester, set the Start and End values to the desired range of frames to be copied. This will cause the copy (or copies) to be made only on the range of frames specified. The Loop, 'Ping-Pong' and 'Reverse' buttons work the same as when you copy an entire file.
- c) To copy an individual frame from the animation into a new still file, first select the appropriate animation file, then use the PAR Deck controls to select the desired frame (information regarding the PAR Deck controls is provided later in this chapter). Select the 'Dup' button, then select the 'Still' button on the requester which appears. PAR will then prompt you for a filename for the new still frame. Click on OK and the operation is completed. The original animation file is not changed in any way.

Note: You can duplicate a frame out of an animation file to create a still file, but you cannot later insert that still into an animation. If you intend to do that, you should duplicate using the Frames option instead of Still.

Join:

This button applies to animation files only. It allows you to join together two animation files into a single file. To use it, select an animation file by clicking on it, then select the 'Join' button. PAR will ask you what animation files you want to join into the original file. Simply click on each desired animation file. Up to three files can be joined to the selected file. Still files cannot be joined in. The combined animation file will retain the name of the original selected file, and the "joined-in" files will no longer exist as separate files.

Split:

This button applies to animation files only. It allows you to split an animation file into two separate files, with a specified split point. The frames including and after the split point are moved to a new file with a new name. To use it, select an animation file, then click on the 'Split' button. PAR will display a requester in which you can specify the split point. You may use the arrow buttons to set the frame number, or type the frame number into your keyboard (remember to hit the Return key!). The original file is split before the specified frame number. In other words, the specified frame number will be the first frame of the new animation file. Click on OK, and PAR will display another requester allowing you to enter a filename for the split-off frames. Click on OK, and the operation is completed.

Append:

This button applies to animation files only. It allows you to directly add frames onto an existing animation file. This is different from Join because Join takes two animation files on the PAR disk and combines them. Append takes any new files that are copied and converted from the Amiga drive (or directly from your animation rendering software), and adds them to the selected animation file. You could accomplish the same thing by starting a new animation file, then joining it to the first one. Append saves you this step.

To use Append, start by selecting the animation file that you wish to add frames to, by clicking on its name in the Files requester. Then click on the 'Append' button. PAR will then display some messages that files are being moved around, in order to put the file into a section of the hard drive where there is available space for the frames that will be appended. Once this disk optimizing is completed, the 'Append' button will be shown in the depressed position. Now you may either convert a file from the Amiga disk drive, or go to your animation program and begin rendering directly to PAR. For more information on these operations, refer to Chapter 5.

Export:

Click on this button to copy the selected animation or still file from the PAR disk onto the Amiga disk, in the currently selected directory.

Figure 4.6

Export
Frames
Requester

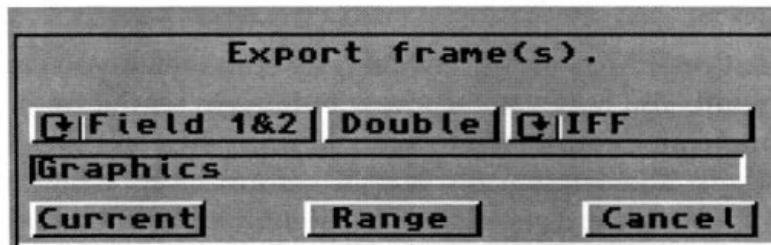

The animation is saved as a separate file for each frame, using file name appended by a frame number (e.g. .001, .002, etc.). When you save a still image, PAR simply uses the same filename. You can avoid any name conflicts with files already in the subdirectory by choosing a different name in the export frames requester.

When you use the Export function, PAR can convert image files into IFF, Toaster framestore, SGI or images may be exported directly as PAR images by selecting the file type using the cycle gadget in the export frames requester..

Note: When files are copied to the Amiga disk using the Save function, the resulting IFF files have already been filtered to remove excessively high color frequencies (see Filter above). If you are going to convert these IFF files into PAR format again at a later time, you should turn off the 'Filter' button during that conversion.

Copy:

Click on this button to copy the selected animation or still file from the current PAR project to a different PAR project.

Move:

Click on this button to move the selected animation or still file from the current PAR project to a different PAR project.

The PAR Record/Play Deck

The PAR Record/Play Deck (or PAR Deck, for short) is the heart of PAR's animation functions. The PAR Deck portion of the PAR control screen is shown in Figure 4-6. Using the deck, you can play your rendered animation at normal 30 frames-per-second speed for recording directly onto videotape. This eliminates the destructive wear and tear on your VTR caused by one-frame-at-a-time recording, which has traditionally been used for computer animation. In fact, it means that you don't even need a VTR with single frame recording capability—you can use any machine which affords sufficient video quality.

Figure 4-7

PAR
Record/Play
Deck

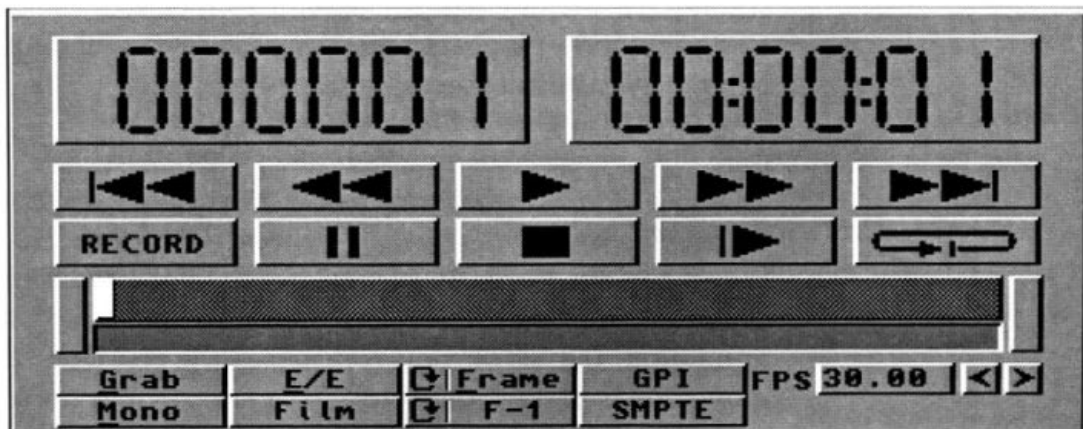

The PAR Deck is also capable (when combined with a DPS TBC-IV card) of recording real-time video and stills directly to the hard disk, which can then be manipulated like an animation file. Video segments and stills captured using this feature can be converted into standard IFF files for rotoscoping. For more information on video capture, refer to Chapter 6.

PAR Deck indicators and controls.

Frame Counter:

This readout shows frame number that is currently being played or recorded. The video output of the PAR card is the frame indicated by this counter.

Time Counter:

This readout shows the current elapsed time of the playback or record function, and is essentially the same as the frame count, but expressed as time. The format is [Minutes: Seconds: Frames], similar to SMPTE time code (non drop-frame mode). Since there are 30 frames per second, the display will increment from 00:00:29 to 00:01:00. Note that in slow motion playback, the Time Counter will display the time as if being played at full speed.

Scrub Bar:

This is similar to the scroll bar of a requester, except that it indicates frames of an animation or recorded video clip. The scroll bar represents the currently played frame, while the scroll box represents the entire file. When the PAR Deck is "rewound" to the start of an animation, the Scrub Bar appears at the left side of the box. As the animation is played, the Scrub Bar moves across the scroll bar, until the entire animation is played, at which time the bar is at the far right.

Like a scroll bar, the Scrub Bar can be moved (by clicking on and dragging it) back and forth to change the current frame. This can only be done when the PAR Deck is stopped.

The area in red below the scrub bar, indicates the selected portion of the animation that will be played back when the 'Play' button is selected. The default is all red meaning the entire animation is selected for playback. To change the starting point for the animation, move the scrub bar to the desired starting point and click on the start select gadget. (The square immediately to the left of the scrub bar) A portion of the red area below the scrub bar will turn gray, indicating that portion of the animation will not be played back. Similarly, you can select where the animation will stop its' playback. Simply move the scrub bar to the desired stop position and select the stop select gadget. (The square to the right of the scrub bar, illustrated at left.) A portion of the red area below the scrub bar will turn gray, indicating that portion of the animation will not be played back.

**Play:**

Clicking on this button causes the PAR Deck to begin playing the animation, beginning at the current frame number, as shown on the counter displays. The current frame number can be controlled by the other deck buttons (such as Rewind and Fast Forward).

The Play function is subject to the setting of the 'Pause' and 'Slow Play' buttons described below.

**Stop:**

Clicking on this button causes the playback to stop. If you start playback again without rewinding, playback will begin at the frame number where you stopped playback. Playback will automatically stop at the end of the animation, unless the 'Loop' button is activated.

**Pause:**

The 'Pause' button, when pressed in, suspends the playback. Clicking on Pause alternately activates and releases the pause function. Of course, if the 'Play' button is not pressed, the pause has no effect.

The 'Pause' button can be released by the GPI (General Purpose Interface), which allows an external device to start playback of the PAR Deck. Refer to the description of the 'GPI' button.



Rewind:

Clicking on the 'Rewind' button causes the PAR Deck to rewind to the beginning of the animation. Rewind can be pressed while the animation is stopped, or while it is playing.



Fast Forward:

Clicking on the 'Fast Forward' button causes the PAR Deck to advance to the end (last frame) of the animation. Fast Forward can be pressed while the animation is stopped, or while it is playing.



Frame Back/Review:

Clicking on the 'Frame Back/Review' button causes the PAR Deck to decrement the current frame number by one frame. Holding the mouse left button while pointing to this button will cause the PAR Deck to scroll backwards through the animation, until the mouse button is released, or until the start of the animation is reached.



Frame Advance/Cue:

Clicking on the Frame 'Advance/Cue' button causes the PAR Deck to advance the current frame number by one frame. Holding the mouse left button while pointing to this button will cause the PAR Deck to scroll forwards through the animation, until the mouse button is released, or until the end of the animation is reached.



Slow Play:

Clicking on the 'Slow Play' button alternately activates and deactivates the Slow Play feature. When the Slow Play feature is activated, playback will occur at a speed determined by the Slow Play Speed gadget. When the this feature is not active, playback will occur at the normal video rate of 30 frames per second. Slow Play does not affect real-time recording speed.

Note that pressing the 'Slow Play' button by itself will not begin playback. The 'Play' button must also be pressed.

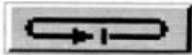
**Loop Playback:**

Clicking on the 'Loop Playback' button alternately activates and deactivates the Loop Playback function. When the button is pressed in, the PAR Deck will repeatedly playback the entire animation sequence. In other words, every time the playback reaches the end of the animation, it will begin again at the beginning. There is a momentary delay between looped playbacks. If you want a particular animation segment to be repeated smoothly, you should use the Duplicate function to create multiple copies in the animation file.

**Record:**

The 'Record' button is used only for real-time video capture. This requires an installed DPS TBC-IV Time Base Corrector card (optional). For information on the use of this function, refer to Chapter 6 (Using PAR for Capturing Video).

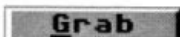
**Grab:**

The 'Grab' button is used for capturing a single frame from an external video source. This requires an installed DPS TBC-IV Time Base Corrector card (optional). For more information on the use of this function, refer to Chapter 6.

**E/E:**

Normally, the video output of the PAR card displays the current frame of the selected animation (or still frame). However, if you are using PAR with a TBC-IV for video capture, you will often need to see the video input signal. Clicking on the 'E/E' button causes the PAR video output to display the video signal applied to the TBC-IV card. Clicking on this button again causes the selected animation or still file to be displayed.

If you are not using PAR for video capture, this button should always be off ("out" position).

Frame

Field/Frame Mode:

This cycle gadget controls PAR's video output when in Slow Play mode. When set to Frame Mode, the Slow Play mode displays video frames just as they are when playing at normal speed: as two interlaced fields (remember that there are two video fields in every frame). However, this can result in some unpleasant effects on the screen if there are any moving objects in the image. This is because the second field represents a slightly later "snapshot" of the scene than the first field, so that moving objects in the two fields are not perfectly superimposed. This can result in a breakup of vertical edges in slow-moving objects, or a back-and-forth shaking in faster objects. These effects become more noticeable as you reduce the Slow Play Speed.

In order to eliminate these problems, you can set the Slow Play to Field Mode. In this mode, the PAR Deck plays back the first field of each frame twice, instead of alternating the first field and second field. This creates a much smoother display.

Note: These motion effects occur only when playing animations that have been rendered in field mode (that is, as individual video fields rather than frames), or when playing animation files containing captured video.

F-1

F-1/F-2:

When the Field/Frame gadget is in the field mode, the F-1/F-2 gadget is used to select between fields 1 or 2.

GPI

GPI:

GPI stands for General Purpose Interface, and it lets you "trigger" the playback of the PAR Deck from an external device (such as an edit controller). When the GPI is triggered, the 'Pause' button is released (if it was set).

To use GPI, you'll need to electrically connect your edit controller to the Amiga's second joystick port. See chapter 1 "Installation" for more details.



Slow Play Speed:

This gadget sets the speed of the Slow Play mode, in frames per second (FPS). It has no effect on normal play mode. You can adjust the setting by clicking on either of the two arrow buttons to the right of the indicator. The range of Slow Play Speed is from 30 FPS (normal speed), down to 0.12 FPS (or about 1 frame every 8 seconds).

Note: In Slow Play mode, PAR must access data from its hard disk in a manner which is not purely sequential, since it must repetitively output a single frame until it's time to show the next one. This takes slightly more time than playing frames out in their normal time base. Therefore, it is possible that if your frames were encoded at a Q-Factor which is very close to the maximum speed of the hard disk, Slow Play at 15 FPS may not operate reliably, even though it plays fine at 30 FPS. The only remedy for this would be to re-do the frames at a lower Q-Factor. This would be an extremely rare case.

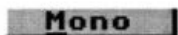

Mono:

This control is used to place the PAR Card into "Forced Monochrome" mode. In Mono mode, all chroma picture detail is suppressed, creating a black and white image. This monochrome video can be combined with color sources in a production switcher since the color "burst" information is still present.

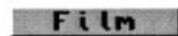

Film:

Choosing the film function allows the selected animation to be played back at 24 frames per second, in order to preview how the animation would appear if the finished product is output to film instead of video.

SMPTE

SMPTE:

The SMPTE gadget can only be used if a Sunrise Studio 16 audio card is installed in your system. Enter the time index for the video to start playing in the requester and click "OK." Then select the "Pause" and "Play" buttons on the PAR deck. When the audio reaches the point specified by the SMPTE time code, the 'Pause' button on the PAR deck will be released. For more information on using SMPTE time code, refer to your Sunrise Studio 16 user guide.

Figure 4-8

SMPTE
Time
Index
Requester

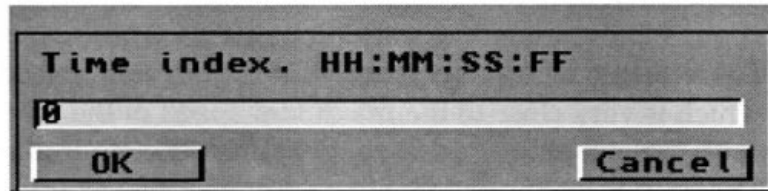

The File Compression Control Gadgets

There are two gadgets in this section, which are used to control the manner in which PAR compresses image files onto its hard disk. The amount of compression and quality of your animation images are determined by the Q-Factor and Block Limit settings.

Figure 4-9

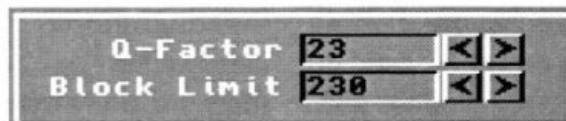

File
Compression
Control
Screen

The block limit represents the number of 512 byte blocks that comprise each animation frame. Increasing the block limit increases the amount of data stored for each animation frame. This improves the image quality at the expense of playback time. If too large a block limit is specified, the disk drive will not be able to transfer the required data in time and the animation playback will break up. By testing a few frames of your animation at various block limit values, you can establish the most appropriate block size for your needs. Check the the appendices for more information about block limits for your specific hard drive. Smaller block sizes are typically required when storing animations on the inner tracks of the hard drive.

The Q-Factor is a relative measurement of the image quality which is inversely related to compression. The Q-Factor will automatically change as frames are converted from IFF, Video Toaster Framestore, Targa or SGI files. The PAR hardware performs a number of automatic tests during the file conversion process to select the highest possible Q-Factor for a given block size and image complexity. By watching this level you assure maximum performance of the product.

When using a DPS Personal TBC IV card to perform realtime video recording to the hard drive, the Q-Factor and block limit values will differ from those used in single frame recording. This is because the 30Hz frame rate of real time recording provides insufficient time for the PAR hardware to automatically scale the Q-Factor and perform filtering. Rather, one must manually scale the Q-Factor to a setting where the whole scene can be

grabbed without generating any error messages. Typical block limits for live video recording will be from 200 to 220 with Q-Factor settings of 6 to 15. The FPS may also be reduced, (say 5 FPS) the Q-Factor will be fixed at whatever you select and if any frame exceeds the block limit it will abort. But you can use larger block limits (up to the playback limit), because the overall “write” through-put is not as high due to the lower FPS. These values are merely suggestions. Feel free to experiment with other values yourself. Also, be sure to check the README file on all PAR software and upgrade disks for other hints or late breaking news.

Q-Factor:

As described above, this gadget sets the amount of compression applied to image files before storing on the PAR hard drive. To set the Q-Factor, click on the arrows to the right of the display value. The left arrow reduces Q-Factor, the right arrow increases it. Or you may click right on the displayed number and enter a new value using your keyboard. Remember to hit Return to enter it. When capturing animation frames, you should keep the Q-Factor setting at 23, since PAR will automatically modify it (for each frame), based on the Block Limit setting. For stills (that is, images converted to PAR with the Anim/Still gadget set to Still), PAR does not do this, because it’s simply not necessary. Stills are replayed on a one-at-a-time basis, so the speed at which data can be read from the hard disk is unimportant. You can safely convert all stills with the Q-Factor set at 23.

However, for real-time video capture, the Q-Factor usually must be reduced. This is because captured video frames are coming in a lot faster than rendered animation frames. There is simply not enough time for PAR to perform the iterative compression technique described above. Therefore, you will have to set a Q-Factor which, based on the complexity of the video images, will guarantee that no frames will exceed the Block Limit. If they do, an error message will be displayed, and recording will be suspended. As a rough guide, a Q-Factor of 8 try using a Block Limit of 200. This is a good starting number.

Block Limit:

The Block Limit gadget sets the maximum allowable size of each PAR compressed animation or video frame. The Block Limit setting that you should use depends primarily on the performance of your hard disk drive. By experimenting with Block Limits, optimum quality can be obtained by PAR.

If the Block Limit is set too high, momentary "flashes" may appear in the video or the recording may "abort." To set the Block Limit, click on the arrows to the right of the display value. The left arrow reduces Block Limit, the right arrow increases it. Or you may click right on the displayed number and enter a new value using your keyboard. Remember to hit "return" to enter it.

The System Control Area

The System Control area of the PAR project manager screen contains three gadgets that you'll need to control the PAR hardware, and to exit from PAR.

Prefs

Prefs:

Double clicking on Prefs brings up a menu (see Figure 4-10) which allows you to control the PAR card's video hardware. The following controls are provided:

Figure 4-10
PAR
Preferences
Screen



M-II:

This button sets the PAR card's Component Analog Video (CAV) outputs to be compatible with M-II levels. It is mutually exclusive with the Betacam mode.

Betacam:

This button sets the CAV outputs to be compatible with Betacam levels. It is mutually exclusive with the M-II mode.

Int/Ext:

This cycle gadget selects the source of timing reference for PAR's video outputs. When it is set to Ext, the PAR card's video outputs will be genlocked to the reference video applied to the Genlock In connector. When the gadget is set to Int, PAR uses its own internal timing generator as a reference.

Genlock Horizontal Control:

This control adjusts the timing of the PAR video output with respect to the genlock reference input. This adjustment may be necessary in order to get the PAR output exactly synchronized with one or more other genlocked video signals, to allow seamless switching, mixing and consistent hue. Each step on this control changes the genlock timing by 270 nsec, which is equal to one cycle of the color subcarrier frequency. Because of this, the Genlock Horizontal control will move the PAR video horizontally, but will not affect the hue (chrominance phase) of the picture.

Genlock Subcarrier Control:

This control adjusts the genlock timing in small steps. Each increment of this control changes the output video timing by 0.55 nsec. Using a V-Scope or conventional vectorscope, you should adjust this setting until the phase of PAR's output video is the same as your other genlocked sources. When you adjust this control beyond the end of its range in either direction, the Genlock Horizontal control will be incremented by one step, and the Subcarrier control will "wrap" to the other end of its travel. This provides you with continuous adjustment over a very large range.

RGB Controls:

These controls will change the default Red, Green and Blue values specified for the PAR control screen. These controls allow you to change the "look" of the PAR screen to your own personal taste. The 'Reset' button will only undo the last change made to the screen. (i.e., the 'Reset' button does not "reset" to factory defaults.)

Format Disk:

This deletes all project and file data from the PAR hard drive, but does not affect the Amiga disk drive(s) in any way. PAR software asks you twice to confirm that you really want to format the disk drive. This operation should be performed whenever a brand-new disk drive is installed into PAR.

TBC-IV

TBC-IV:

Clicking on this button brings up the control screen for TBC-IV, if you have it installed and running. PAR software will continue to run without interruption. To return from TBC-IV control to the PAR screen, simply click on the 'Recorder' button in the TBC-IV screen. This gives you a quick way of going back and forth to the TBC-IV control.

Quit

Quit:

Clicking on this button shuts down PAR software, and returns you to AmigaDOS.

CHAPTER 5

Using PAR For Animation Recording

Introduction:

PAR's primary application is to record computer-rendered animation images, one frame at a time, onto its dedicated hard disk. When the animation is completed, the frame sequence can be played and displayed as a full-motion animation. That means you can record it onto videotape (in NTSC, S-VHS, Betacam or M-II format and quality!) in real-time, without using an expensive single-frame VTR.

What's more, you can do this with virtually no change to the way you use your animation rendering program. This section gives detailed instructions on how to use PAR in this application.

Animation Recording: Two Ways to Go

There are two ways that you can use PAR as an animation recorder: intermediate file conversion and direct capture.

Using the intermediate file method, your animation software is set up to save rendered files onto the AmigaDOS hard disk, in either IFF, Toaster Framestore, Targa and SGI formats. Later on, PAR software is used to copy those files from the AmigaDOS disk, compress and convert them to PAR format, and write them onto the PAR hard disk. The original rendered files remain on the AmigaDOS disk.

In direct capture, on the other hand, the rendering program sends image data directly to PAR, without first writing it to the AmigaDOS disk. This is done by configuring your animation program to save its rendered images onto a "virtual disk" or device, which is in fact the PAR card. PAR automatically defines this virtual disk (labeled "DDR") for you when you start up the program. The AmigaDOS operating system and the rendering software are "fooled" into thinking that they are saving the images directly to a hard drive, when in fact they are being sent to the PAR card for processing and storage.

The advantage of using the intermediate file method is that you need less memory in your Amiga (PAR needs a minimum of 1.2 Mbytes at all times), by not running PAR at the same time as your animation program.

The advantage to the direct capture method is that you don't need a large capacity on your AmigaDOS hard disk drive. Considering that each animation frame (say, in IFF format) might require 700 Kbytes, a 30-second animation would require over 600 Mbytes of hard disk. PAR can easily handle 3 to 5 minutes of animation on a typical 500 Mbyte drive. Unless you have a very large drive, or are dealing only with very short animation segments, we recommend that you use the direct capture technique. Both methods are described below.

Direct Capture Method

Step 1:

Start PAR Software

The first step is to get PAR software running and properly configured. To start PAR software, follow the instructions in Chapter 4.

Step 2:

Define Project

Next, you must define a project or subdirectory in PAR to store the image files. Click on the 'New Project' button and enter a project name, then click on OK. For more information, see Chapter 4. (PAR Project requester)

Step 3:

Set PAR Controls

There are four controls on the PAR screen which will affect the way that PAR receives image files:

- The Anim/Still selector: must be set to Anim for animations
- The 'Filter' button (see Chapter 4, Page 46)
- The Q-Factor setting (see Chapter 4, Page 65)
- The Block Limit setting (see Chapter 4, Page 65)

Refer to the individual sections for more description on how to use these controls. In most cases, however, you can set the Anim/Still to Anim, the 'Filter' button ON, the Q-Factor to 23 and the Block Limit to 200.

Step 4:**Start and Configure Rendering Software**

Now you have to start up your image rendering software, but first you'll have to get out of the PAR screen without quitting the program. To do this, press the left 'Amiga' key on your keyboard (just to the left of the space bar) at the same time as the letter 'M'. This will take you to the Workbench screen.

From here, navigate to and start up the rendering software of your choice.

The only set-up change that you'll have to make in the rendering program is the path for saving image files. In the past, you've probably saved to a sub-directory of the hard drive (DH0), or perhaps to floppy disks (DF0 or DF1). With PAR, however, you'll want to save rendered image files to a new device called "DDR", which PAR has defined to the AmigaDOS operating system.

Every animation program is slightly different, but they all provide you with a menu under which you can specify the device, path and filename where rendered images will be saved.

For example, when using LightWave 3D, under the Record settings, there is a requester for Save Images. This allows you to specify how and where images (assuming you want to use IFF format files) are saved. When you bring up this menu, you'll see that there are buttons for selecting which disk the images are to be saved on. There are buttons for DF0, DF1, DH0, and the RAM disk. Obviously, there is no button for the "DDR" virtual disk.

Figure 5-1

Animation
File
Transfer
Status
Screen

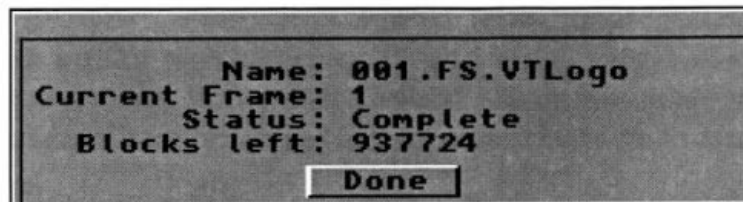

Don't panic. You can specify any other device by clicking on the Path direct entry window. Type in "DDR:", hit Return, and in the file requester window you will see the project that you defined in PAR. Click on the project, and it will be appended to the path.

One more step:

You have to specify a base filename for the animation. In LightWave, you click on the file requester window at the bottom of the Save Images screen, type in a file name using the keyboard, and hit Return. LightWave will use this as the base file name, and append a frame number to it for each rendered frame.

Step 5:

Animation Rendering

From here, you use your animation software as usual, and when you execute the Render function, the individual frame images are created and sent to the DDR device (which is actually the PAR card and disk drive).

If you want, you can switch to the PAR screen while the animation software is rendering. You should see a message (Figure 5-1) indicating that PAR is receiving the rendered image file, the filename, and the current frame number. While the image is being received by PAR, the Status line will read "In Progress". Then, when PAR is compressing the file, the Status will indicate "Transferring", followed by "Complete". This indicates that the frame transfer is complete, not necessarily the entire animation, since PAR does not know how many frames to expect.

Below the Status line is an indication of the number of blocks available on the PAR hard disk. A block is 512 bytes. This lets you know how much room you have left for your animation.

Step 6:

Closing the File

When the rendering is finished, you must go to the PAR screen and close the file. Do this by clicking on the Done gadget in the animation file transfer status screen. PAR will prompt you for a filename for the animation. The default is the filename that you entered into your animation software, but without the appended frame numbers. Remember that you must close the file before you begin a different animation, or PAR will join the two together.

Type in the desired filename and click on OK. You're finished capturing the animation to PAR's disk!

Step 7:

Playing and Modifying the Animation

You can now play the animation as if it were on videotape. The animation that you just created is already selected in the File Requester; to watch it, use the controls on the PAR Deck (described in Chapter 4) to play, rewind, fast forward, etc.

You may wish to modify the animation file by duplicating it repetitively, "Ping-Pong" it, join it with other animations, etc. PAR is equipped with powerful editing features that let you perform such manipulations. For details on how to use these controls, refer to Chapter 4.

Step 8:

Transfer to Video Tape

When you are satisfied with the animation file, you may wish to transfer to video tape, to become part of a larger production. The simplest way to do this is to simply play the animation while your video tape recorder is connected to the video output of the PAR card (or via a switcher).

If you are using an on-line automated editing system, you will need to connect PAR to the edit controller via the General Purpose Interface (GPI) trigger. This will allow the edit controller to "UN-Pause" the

PAR deck when playback of the animation is required. For details on use of the GPI, refer to Chapter 4.

Intermediate File Method

Step 1:

Render Animation

In the file transfer method, you may completely render your animation before you even start up the PAR software. This may be an advantage if you have limited memory in your computer, and you cannot run PAR at the same time as your other programs.

Using your animation program, save the rendered image files (in either 24-bit IFF, Toaster Framestore, Targa or SGI format) onto any directory of the AmigaDOS disk drives.

Step 2:

Start PAR Software

The next step is to get PAR software running and properly configured. To start PAR software, follow the instructions in Chapter 4.

Step 3:

Define Project

Next, you must define a project or subdirectory in PAR to store the image files. Click on the 'New Project' button and enter a project name, then click on OK. For more information, see Chapter 4, (PAR Project requester)

Step 4:

Set PAR Controls

There are four controls on the PAR screen which will affect the way that PAR copies and converts image files:

- The Anim/Still selector: must be set to Anim for animations
- The 'Filter' button (see Chapter 4, Page 46)
- The Q-Factor setting (see Chapter 4, Page 65)
- The Block Limit setting (see Chapter 4, Page 65)

Refer to the individual sections for more description on how to use these controls. In most cases, however, you can set the 'Anim/Still' button to 'Anim', the 'Filter' button ON, the Q-Factor to 23 and the Block Limit to 200.

Step 5:

Select Animation Frames

On the PAR project screen, use the AmigaDOS File Requester and its associated controls to go to the disk and subdirectory where your rendered animation files are. Then select the desired animation frames which will be copied and converted onto the PAR disk.

To get to the desired disk and subdirectory, you'll use the 'Disks' and 'Parent' buttons, as well as the mouse pointer to click on subdirectories displayed in the file requester as described in Chapter 4 ("Navigating through AmigaDOS Devices and Subdirectories).

When you've reached the appropriate subdirectory, you must select the files to be converted by clicking on them. Selected files will be shown in reverse text (white letters on a black bar). Clicking again on a selected file will de-select it. If all of the files in the subdirectory are to be converted into a single animation, you can simply select them all using the 'All' button.

Step 6:

Copy and Convert

Execute the conversion function by clicking on the 'Convert' button. PAR will prompt you for a file name for the new animation. Enter the desired name, and click on OK (or hit Return). PAR will now copy all selected files and build them into an animation, in the sequence in which they appear in the file requester.

You'll see a status message, indicating that PAR is working, the current frame number and the total number of frames. When the conversion is finished, the status message disappears.

Step 7:

Playing and Modifying the Animation

You can now play the animation as if it were on videotape. The animation that you just created is already selected in the File Requester; to watch it, use the controls on the PAR Deck as described in Chapter 4, to play, rewind, fast forward, etc.

You may wish to modify the animation file by duplicating it repetitively, "Ping-Pong" it, join it with other animations, etc. PAR is equipped with powerful editing features that let you perform such manipulations.

Step 8:

Transfer to Video Tape

When you are satisfied with the animation file, you may wish to transfer to video tape, to become part of a larger production. The simplest way to do this is to simply play the animation while your video tape recorder is connected to the video output of the PAR card (or via a switcher).

If you are using an on-line automated editing system, you will need to connect PAR to the edit controller via the General Purpose Interface (GPI) trigger. This will allow the edit controller to "UN-Pause" the PAR deck when playback of the animation is required.

CHAPTER 6

Using PAR For Capturing Video

Introduction

When you add a Digital Processing Systems TBC-IV card to the PAR, you can capture high-quality real-time video and stills, for a wide variety of applications. PAR's video capture features fall into two main categories: still frame "grabs" and recording. This chapter describes these operations in detail.

Before you can perform these functions, however, you'll have to install and set up the TBC-IV card. Note that the TBC-IV card must be installed in a PC card slot immediately adjacent to the PAR card, since the supplied 50-pin ribbon cable for the Component Video Exchange (CVE) bus is quite short. Refer to the TBC-IV manual, and Chapter 1 of this manual for installation and cable interconnection details.

Still Frame Grabs

Step 1:

Start PAR Software

The first step is to get PAR software running and properly configured. To start the PAR program, follow the instructions in Chapter 4.

Step 2:

Define Project

Next, you must define a project or subdirectory in PAR to store the grabbed frame files. Click on the 'New Project' button and enter a project name, then click on OK. If there is an existing project you wish to add to, click on its name instead. For more information, see Chapter 4. (PAR Project requester)

Step 3:

Set PAR Controls

There is only one control that will affect the way in which PAR grabs a still video frame: the Q-Factor setting. This should be set to 23, the highest quality level. For more information on Q-Factor settings, refer to Chapter 4.(File compression control gadgets)

Step 4:

Preview Video

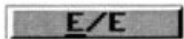

Assuming that you already have your video source (camera, VTR, laserdisk, computer, etc.) connected to the video input of the TBC-IV card, you can view it by clicking on the 'E/E' button of the PAR Deck. At the video output of the PAR card, you will see the same video applied to the TBC-IV, after it has been processed by the time-base corrector, transferred to the PAR card via the Component Video Exchange bus, and converted back into analog format.

Step 5:

Grab Still Frame and Provide File Name

When the desired image appears on your monitor, grab it by clicking on the 'Grab' button on the PAR Deck. With virtually no delay, PAR captures the latest video frame, then compresses and stores the data to its hard disk. Note that the grabbed image is always stored as a still frame, not as an animation. If you want to grab several times into an animation, use the "Manual" option of video recording (see Chapter 6, Video Recording).

PAR then asks you to enter a file name for the still frame. Type the desired file name and click on OK, or hit Return on your keyboard.

The grabbed still will now appear in the file requester window. Try clicking on a different item in the requester, then click on the still that you just grabbed. The video monitor on the PAR output will immediately display the selected image.

Note that any motion that was taking place in the video when you grabbed the frame will result in some distortions. This is because a frame of video is composed of two interlaced fields, one slightly later in time than the other. Therefore, when the two fields are displayed as a static image, the objects in the two fields may not be in exactly the same position.

If the motion was slight, you'll see some breakup on the vertical edges. If the motion was greater, you'll see the moving object in two positions, flickering back and forth. Either way, this can be annoying. When displaying the grabbed frame at PAR's video output, you can eliminate the effect of inter-field motion by setting the PAR Deck to Field mode, by clicking on the Field/Frame cycle gadget.

If you are going to import the grabbed image to your animation program, you will probably have to de-interlace the frame, and discard one of the two fields, using the utilities of your animation program.

Step 6:**Copy Image to AmigaDOS Disk**

At this point, you may wish to move the grabbed still image into your animation program to modify it in some way, or to use it as a background or surface. To do this, you'll use PAR's export function.

First, select the AmigaDOS disk and subdirectory where you want to put the grabbed image file. To get to the desired disk and subdirectory, you'll use the 'Disks' and 'Parent' buttons, as well as the mouse pointer to click on subdirectories displayed in the file requester. For more details, refer to Chapter 4, "Navigating through AmigaDOS Devices and Subdirectories."

Make sure that the grabbed image file is selected in the PAR File Requester. Then, click on the 'IMP/EXP' button under the AmigaDOS file requester and select the desired format for exporting, (IFF, Framestore, Targa or SGI). Then, click on the 'Export' button under the PAR files requester. The image will then be de-compressed, converted to the selected format, and written to the AmigaDOS disk subdirectory. PAR uses the same filename for the file that was used for the PAR file. Make sure you avoid any name conflicts with files already in the subdirectory.

Note: When files are copied to the Amiga disk using the Save function, the resulting IFF files have already been filtered to remove excessively high color frequencies (see Chapter 4, describing the 'Filter' button). If you are going to convert these IFF files into PAR format again at a later time, you should turn off the 'Filter' button during that conversion. However, if you have added any objects or images with your animation programs, then you should have the 'Filter' button turned on.

Video Recording

Step 1:

Start PAR Software

The first step is to get PAR software running and properly configured. To start the PAR program, follow the instructions in Chapter 4.

Step 2:

Define Project

Next, you must define a project or subdirectory in PAR to store the recorded video. PAR stores recorded video segments as an animation file. Click on the 'New Project' button and enter a project name, then click on OK. If there is an existing project you wish to add to, click on its name instead. For more information, see Chapter 4, (.PAR Project requester)

Step 3:

Set PAR Controls

PAR's image compression controls must be set carefully when recording video. Unlike animation capturing, real-time video is coming in at a constant 30 frames-per-second. Therefore, there is not enough time for PAR to iteratively find the optimum Q-Factor when compressing each frame, as it can for animation-generated images. For more information on Q-Factor, refer to Chapter 4, "The File Compression Control Gadgets".

If a recording is attempted with the Q-Factor set too high, the resulting data rate may be too high for the hard disk. PAR detects an excessive data rate by comparing each compressed frame against the Block Limit setting. If the Block Limit is exceeded, the recording will be suspended, and an error message is displayed. Try the recording again with the Q-Factor set lower. Reduce the limit until no error messages occur. With a Block Limit of 220 (recommended for Micropolis 2217A disk drives), a Q-Factor of 14 is a good setting to use in most cases.

Step 4:

Preview Video

Assuming that you already have your video source (camera, VTR, laserdisk, computer, etc.) connected to the video input of the TBC-IV card, you can view it by clicking on the 'E/E' button of the PAR Deck. At the video output of the PAR card, you will see the same video applied to the TBC-IV, after it has been processed by the time-base corrector, transferred to the PAR card via the Component Video Exchange bus, and converted back into analog format.

Step 5:

Recording

Initiate your recording by clicking on the 'Record' button of the PAR Deck. When you do this, PAR will display a requester (Figure 6-1, Record Frames) which offers you some recording options.

Figure 6-1

Record
Frames
Screen

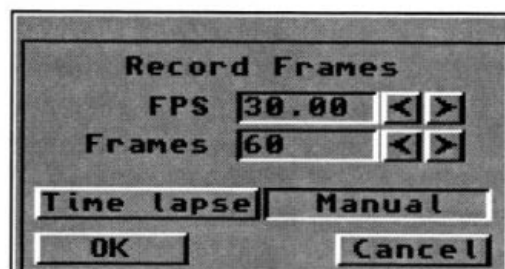

Normal Recording:

This mode records just like a plain old videotape recorder would. On the Record Frames requester, make sure that the FPS (frames-per-second) selector is set to 30.0.

Make sure that both the 'Time Lapse' and 'Manual' buttons are out (off).

Then, in the Frames window, enter the number of frames that you wish to record. Bear in mind the capacity of your PAR hard disk. If you attempt to specify more frames than you have room for, PAR software will automatically adjust this number for you. If you record the maximum number of frames that PAR will allow, you may find that there is still some unused disk space. This is because PAR estimates disk space requirements based on the worst case, that is, with each frame equal to the Block Limit. This may not be the case, depending on the picture content, so some space may still be available.

When the desired video appears on the monitor, begin recording by clicking on OK. The PAR Deck will record and compress the requested number of frames. When recording is completed, PAR will ask you for a file name to save the video frames. Enter a file name and click on OK; you'll see the new file appear in the PAR File Requester.

Stunt Recording:

This mode is similar to normal recording, except that not every frame of source video is captured. Instead, the recording is set to a lower rate (by setting the FPS value to something lower than 30.0). Other settings in the Record Frames requester are used in the same way as Normal recording, described above. When the recording is started, PAR samples the source video at the specified frame rate, skipping all other frames.

If a video segment recorded at, say, 3 FPS is replayed at 30 FPS, it will appear to be moving 10 times faster than normal. If it is replayed at 3 FPS, it will appear to have normal speed, but motion will be “frozen” every 1/3 of a second.

When using Stunt Recording, you can set the FPS value to as low as 0.12 FPS. However, if you want to go below 1 FPS, Time Lapse Recording (below) is recommended.

Time Lapse Recording:

This mode is used to capture very slow moving objects (when motion is barely perceptible), and show them at an accelerated rate. You can control the amount of motion acceleration by setting the time lapse record rate, in seconds-per-frame (SPF). The PAR recorder can operate from 1 SPF (30 times acceleration) to 32,000 SPF (about 1 million times acceleration). At 32,000 SPF, a year of real time will be displayed in slightly over 30 seconds.

Figure 6-2

Time
Lapse
Record
Screen

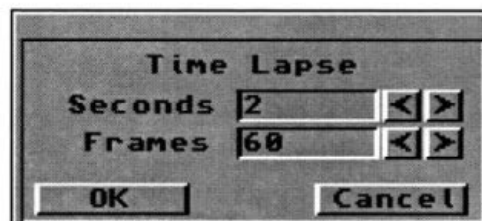

To engage Time Lapse Recording, click on the ‘Record’ button. In the Record Frames requester which appears, click on the ‘Time Lapse’ button, then click OK. A new requester, called “Time Lapse” will appear. Here, you can select the SPF recording rate (in the “Seconds” window), as well as the total number of frames. When you’re ready to begin recording (most likely from a camera), click on OK. The recording process will begin; some time later, maybe much later, the requested number of frames will have been recorded, and PAR will prompt you for a file name to save the captured video.

Manual Frame Recording:

In Manual Frame Recording, each frame is recorded whenever you manually trigger it, using the mouse. Unlike the Grab function, Manual Frame recording stores its images as an animation file, rather than as a still file. This can be useful if you are animating real objects, and capturing them with a camera.

To use Manual Frame Recording, click on the 'Record' button. When the Record Frames requester appears, click on the 'Manual' button so that it is engaged (in). Select the number of frames desired, then click on OK. PAR will display a requester for a file name to save the recording. Enter the desired filename, then click on OK. A new requester ("Recording Animation") will appear. The recorder is now ready to grab frames.

Figure 6-3

Manual
Frame
Record
Screen

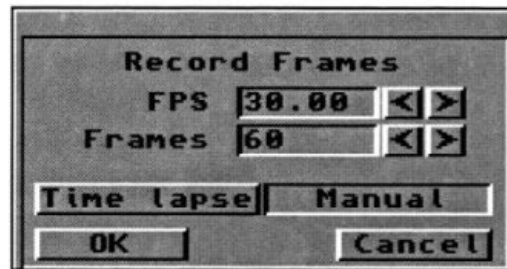

Each time you click on the 'Grab' button in the Recording Animation requester (don't use the 'Grab' button on the PAR Deck!), a frame will be recorded. After the first frame is recorded, the requester will show the current frame number (that is, the one just recorded, the total number of frames to be grabbed, and the number of blocks available on the hard disk (one block is 512 bytes).

When the last frame has been grabbed, the requester will disappear and recording is concluded. The new animation file will appear in the PAR Files Requester. You may quit a manual frame recording session by clicking on Done. The frames already grabbed will still be saved in the named file.

Step 6:**Check Recording (Playback Video)**

After you've finished recording in one of the four modes described above, you'll want to check your recording by playing it back. The PAR Deck should already be rewound, so all you have to do is click on the 'Play' button, and the captured video will be output from the PAR card to your monitor. For more information on the use of the PAR Deck controls, refer to Chapter 4, "The PAR Record/Playback Deck." At this point, you may perform certain manipulations to the captured video (animation) file, such as Rename, Duplicate, Join, Split or Delete as outlined in Chapter 4..

Step 7:**Copy to AmigaDOS Disk**

Finally, you may wish to move the grabbed video file into your animation program to modify it in some way, or to use it as a background or surface. To do this, you'll use PAR's export function.

First, select the AmigaDOS disk and subdirectory where you want to put the grabbed video file. To get to the desired disk and subdirectory, you'll use the 'Disks' and 'Parent' buttons, as well as the mouse pointer to click on subdirectories displayed in the file requester. For more details, refer to Chapter 4, "Navigating through AmigaDOS Devices and Subdirectories."

Next, make sure that the grabbed video (animation) file is selected in the PAR File Requester. Then, click on the 'IMP/EXP' button under the AmigaDOS file requester and select the desired format for exporting, (IFF, Framestore, Targa or SGI). Then, click on the 'Export' button under the PAR files requester. PAR will display a requester asking you if you want to convert only the currently displayed frame (the frame number will be shown on the PAR Deck), or a range of frames (such as the entire video file).

Click on Frames, and another requester will appear, allowing you to select the start and end frame number (inclusive) to be converted and saved. The default values will convert all the frames in the file.

Click on OK. PAR will then de-compress each frame in the file, convert it to the pre-selected format, and write it to the selected AmigaDOS disk subdirectory. PAR uses the same filename for each IFF file that was used for the PAR file, but with the frame number appended as an extension (e.g. .001, .002, etc.). Make sure you avoid any name conflicts with files already in the subdirectory.

Note: When files are copied to the Amiga disk using the Save function, the resulting IFF files have already been filtered to remove excessively high color frequencies (see Chapter 4, describing the 'Filter' button). If you are going to convert these files into PAR format again at a later time, you should turn off the 'Filter' button during that conversion. However, if you have added any objects or images with your animation programs, then you should have the 'Filter' button turned on.

Play -N- Grab

Stop Motion Animation is the practice of recording an animation sequence using video cameras, a still store (frame store) and some props. This is the traditional technique used in the popular claymation type of animation. Typically you would have some kind of puppet or object that can be manipulated by small amounts, moving hands, legs, and arms, recording each slight movement so that when the frames are played back sequentially, the object appears to have a life of its own. The traditional equipment for this would be a combination of some kind of freeze frame equipment to grab each image, some storage for the images, and a genlock so that you can compare the frozen image with the next (live video) image, by cross fading back and forth between still store and live video. The problem with this method is that it is very hard to get an overall sense of motion because you can only preview one frozen image, and one live image.

The PAR now has a new video digitizing mode that makes this type of animation much easier. This mode is known as PLAY-N-GRAB, the term itself describes the action of the PAR. The PAR will PLAY a series of frames that have been previously recorded, then at the last frame of animation it will

switch to the live video E/E input from the TBC-IV so that you can GRAB the next frame when you are satisfied with the position of your puppet or object. The PAR will continuously PLAY the animation and switch to E/E until you exit the Play-N-Grab function by selecting the stop button from the VCR controls.

To use 'Play-N-Grab', you will first have to record the base portion of the video. Record 30 or more frames of video so that you have some video to work with. Next, set the inpoint and outpoint so that the video is playing back from frame 1 to frame 30. This will limit the preview portion of the playback (pre recorded video) to the last 30 frames. When you add more frames, the preview portion will automatically move up by one frame for each frame of video added. For instance if you have frames 1-30 the preview will play frames 1-30 then switch to live video at what would be frame 31, when you add this frame to the sequence, the preview will now play back frames 2-31 and will switch to live video at frame 32. The next step is to move to the actual recording mode. With the PAR animation that you are going to be working with selected in the FILES area, go to PREFS and select the 'Play-N-Grab' button. Then close the PREFS window and select LOOP mode and PLAY. You should now have a looping sequence of 30 or so frames. You will see the animation sequence playback and then switch at the last frame to live video. Make sure that you are working with valid Q-Factor and Block Limits. When you are ready to add the live video to the preview sequence, press ZERO on the numeric keypad. You will now have added one more frame of animation as part of the sequence.

This is an example of using the PAR to capture some stop frame animation.

- Hook a camera up to one of the inputs on the TBC-IV.
- Place a small object in front of the camera making sure it is visible by the camera.
- Make sure that stable live video is coming through the PAR by selecting the E/E button on the main PAR screen.
- Record 30 frames of video using the standard method. You should now have 30 frames of an unmoving object.
- Set the INPOINT of the animation by selecting the vertical control bars on the left hand side of the PAR slider.
- Open the PREFERENCES window by selecting the PREFS button from the main PAR screen, then select the 'PLAY-N-GRAB' button. Close the PREFERENCES window.
- Set the PAR to LOOP mode by selecting the LOOP button from the VCR control panel.
- Select the PLAY button on the VCR controls.
- Now move the object slightly in front of the camera, noting the object's position during the live video frame. You can see the difference between the pre recorded video and the objects new position. When you are satisfied with the objects new position, then grab the video frame by pressing the ZERO key on the numeric keypad.
- Repeat step 9 until you finish the animation sequence.

CHAPTER 7

Using PAR for Still Frame Storage

Introduction

In addition to its animation functions, PAR can operate as a video still frame storage system. While many such systems exist for use on a variety of computer platforms, PAR is unequalled in terms of its display access speed, capacity, ease of video capture, image quality and price/performance ratio.

Still frames can originate as 24-bit IFF, Toaster Framestore, Targa or SGI files. Either way, PAR copies and compresses them onto its own hard disk. Alternatively, still frames may be “grabbed” from a video source, when a TBC-IV card is installed with PAR in the Amiga.

What about capacity? When PAR is used with the recommended 500 Mbyte hard disk, it can typically store 10,000 still frame images! Actual capacity may vary, depending on image complexity and Q-Factor setting, but even with the most complex images, you can get 6,000 onto the disk.

How to Use PAR for Still Frame Storage

Everything you need to know about using PAR for still frame storage has been described in the previous chapters. Rather than reprint it all here, please use the following cross-references:

Starting PAR software: see Chapter 1 (Getting Started)

Creating Projects and selecting still images for display: see Chapter 4, “The PAR Projects and Files Requester.”

Converting still files from 24-bit IFF, Toaster Framestore, Targa or SGI files: see Chapter 4, “The AmigaDOS Files Requester”

Grabbing still frames from video: see Chapter 6, “Still Frame Grabs”

Note: If you are using PAR for both animations and stills, avoid storing stills as frames in an animation file. This is because animation files are kept in the fastest areas of the PAR hard drive (nearest the outer edge of the disk), while stills are stored in the slower areas (nearer the middle of the disk).

If you use the animation storage areas for stills by defining them as animations, you are forcing the true animations into the slower parts of the disk. This may limit the quality of your animation images by preventing you from using higher Block Limit settings.

APPENDIX A

Compatible Hard Disk Drives

Any hard disk for use with the Personal Animation Recorder must be IDE type. SCSI interfaces are not supported.

Manufacturer:.....Seagate
Model:3600A
Capacity:.....540 Mbytes
Recommended Block Limit:154

Manufacturer:.....Seagate
Model:3655A
Capacity:.....540 Mbytes
Recommended Block Limit:170

Manufacturer:.....Seagate
Model:ST5660A
Capacity:.....540 Mbytes
Recommended Block Limit:200

Manufacturer:.....Seagate
Model:ST31220A
Capacity:1 Gbytes
Recommended Block Limit:200

Manufacturer:Micropolis
Model:2205A
Capacity:.....542 Mbytes
Recommended Block Limit:240

Manufacturer:Micropolis
Model:2210A
Capacity:.....976 Mbytes
Recommended Block Limit:240

Manufacturer:Micropolis
Model:2217A
Capacity:1.6 Gbytes
Recommended Block Limit:240

Manufacturer:Conner
Model:CFA540A
Capacity:540 Mbytes
Recommended Block Limit:200

Manufacturer:Conner
Model:CFA1080A
Capacity:1.0 Gbyte
Recommended Block Limit:200

Manufacturer:Conner
Model:CFA1275A
Capacity:1.275 Gbyte
Recommended Block Limit:240

Figure A-1
Micropolis
2200A Series
Jumpers
and
Connectors

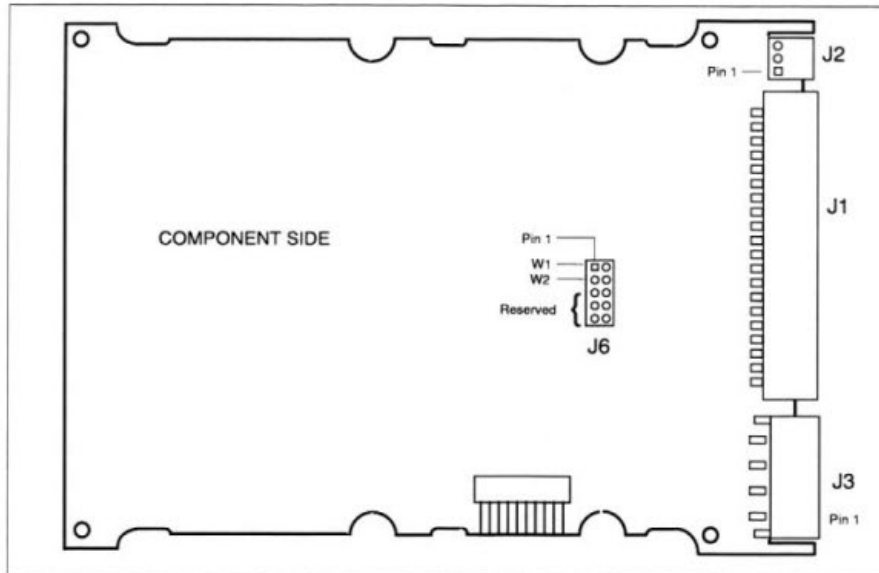

Using the Micropolis Drives with PAR

Locate the jumper block labeled J6 on the component side of the Micropolis drive. If only one drive is being installed, J6 should not have any jumpers installed in the W1 and W2 positions. (The W1 position is the position furthest from the power connector J3.)

If two drives are being installed, you will require a ribbon cable that supports this configuration. (Any standard IDE interface cable, available from most computer dealers will do) Follow the procedure outlined in Chapter 1, for instructions on installing this cable.

On the drive intended to be the master, remove jumper W2 and check that jumper W1 is installed. On the drive intended to be the slave, check that jumper W2 is installed and jumper W1 is removed. Install the hard drive(s) into your computer according to the instructions outlined in Chapter 1.

Note: If a Micropolis and Seagate drive are installed on the same PAR card, both drives need to be set as master.

Figure A-2

Conner
CFA 540A
CFA1080A
CFA1275A
Jumpers
and
Connectors

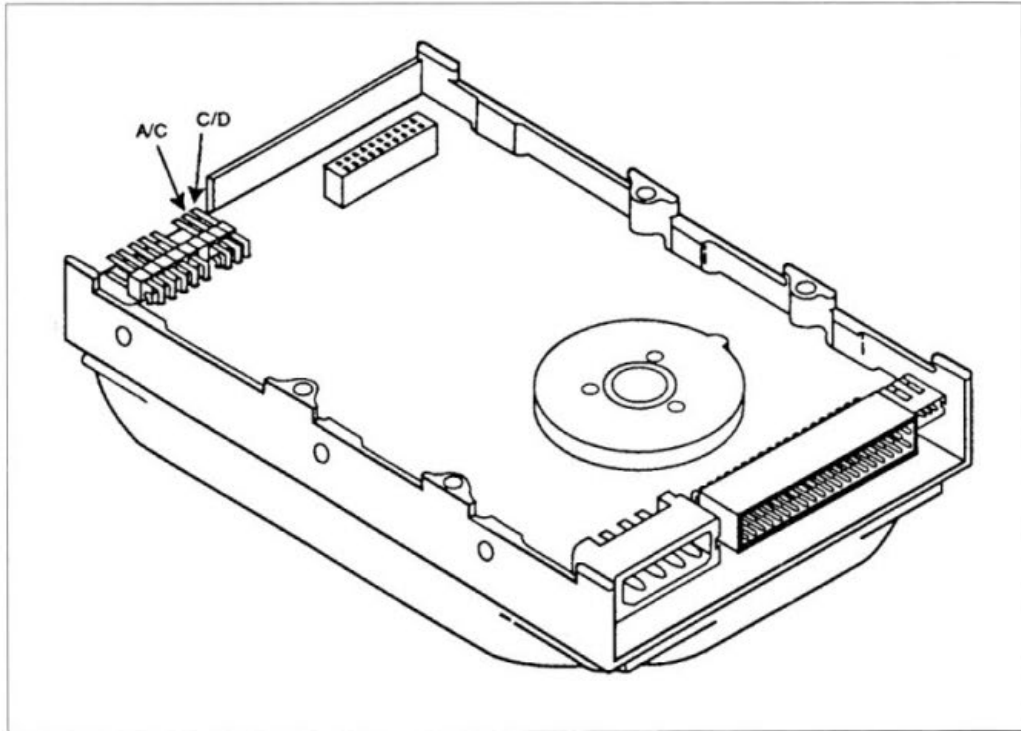

Pins:	Signal	Description
1 and 2	C/D	Open: Drive will act as slave. Closed: Drive will act as master
3 and 4	A/C	Open: Conner master/slave mode Closed: ATA/CAM master slave mode

Figure A-4
Seagate
ST3655A
Jumpers
and
Connectors

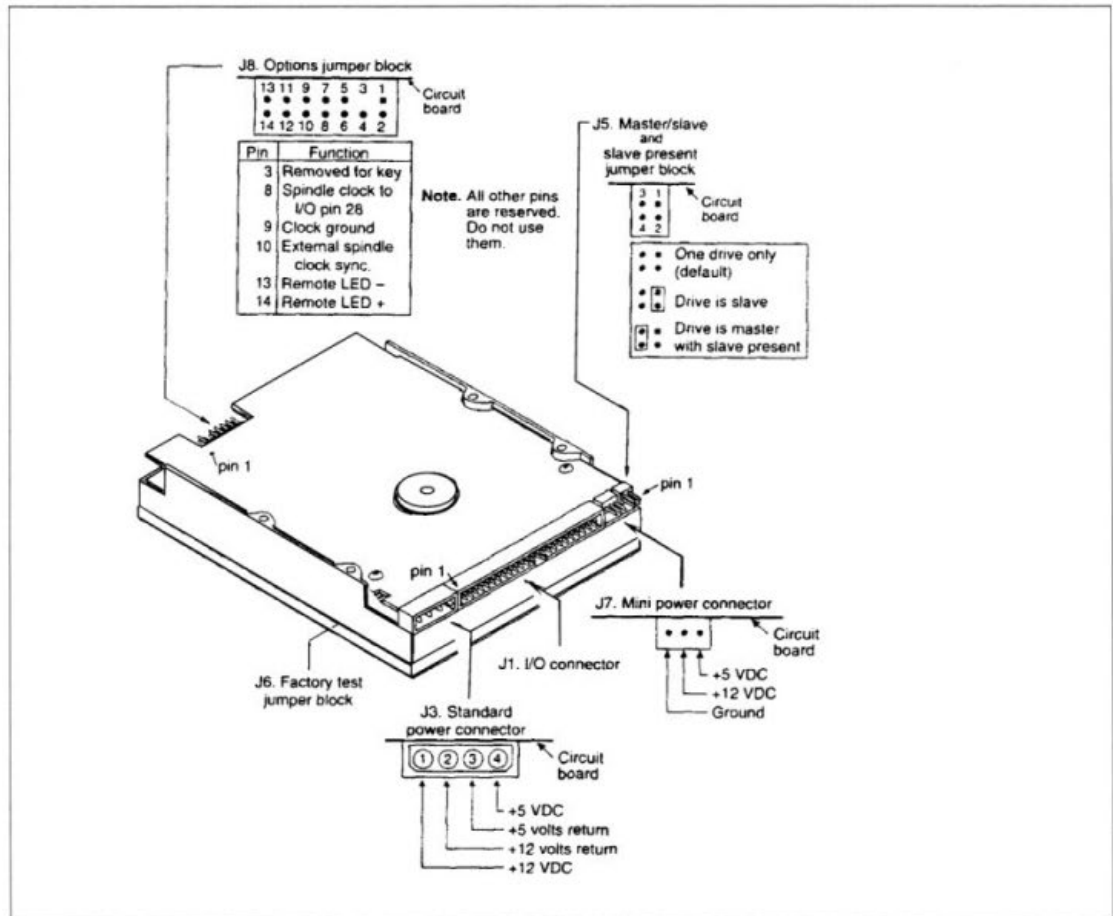

Intentionally
Left
Blank

APPENDIX B

Specifications

Output Signal Formats:

Composite NTSC1V p-p 75Ω

S-Video (4-Pin):

Y Signal.....1V p-p 75Ω

C Signal.....600mv p-p 75Ω

Betacam CAV (BNC's):

Y.....714mv p-p 75Ω

R-Y.....700mv p-p 75Ω

B-Y.....700mv p-p 75Ω

MII CAV (BNC's):

Y.....700mv p-p 75Ω

R-Y.....486mv p-p 75Ω

B-Y.....486mv p-p 75Ω

Notes:

- All levels correspond to 75% Color signal.
- Betacam/MII outputs share BNC's, output format is selected via software.

Genlock Input:

Composite NTSC1V p-p 75Ω

Notes:

- Genlock signal may be color black or any time base stable NTSC signal.
- Genlock input may be 75Ω or Hi-Z bridging, jumper selectable.

Video Performance:

Frequency Response.....	± 0.5 dB (0-4.2 MHz)
3 dB (> 5.5 MHz)	
K-Factor (2-T).....	< 1%
Differential Phase.....	< 1°
Differential Gain.....	< 1 %
Signal/Noise.....	> 60 dB (Luma Weighted)

Notes:

- Test signals generated using DPS Personal TSG software.

Power Consumption:

+5V	1.4 Amps
+12	150 mA
12V	60 mA
Total.....	9.5 Watts

Notes:

- Excludes disk drive.

Storage Capacity:

Stills	
(Typical).....	> 10,000 Frames
(Minimum).....	> 6,000 Frames

Animation

(Typical).....	> 5 Minutes
(Minimum).....	> 3 Minutes

Notes:

- Capacities based on 500 Mbyte disk drive.
- Typical values are based on minimum compression, for average TV frame.
- Minimum values are based on minimum compression, for worst case TV image.

Control Software:

Recording:

- Supports IFF, Targa, SGI, YUV (proprietary) , PAR and Video Toaster Framestore files.
- Simulates AmigaDOS device, for direct rendering.
- Can build Animation from standard AmigaDOS files, with automatic file sequence recognition.
- Manual and Automatic compression control for optimum disk utilization.

Playback:

- Realtime 24-bit animation playback.
- Variable speed playback to 30 Frames/Second.
- Single frame advance/retard for browsing.
- Instant access to stills with glitch free switching.

Intentionally
Left
Blank

APPENDIX C

Keyboard hotkeys:

Del - delete selected file.
+/- and up/down arrows on keypad - move up/down thru files.
HOME/END on keypad - select first/last file.
PgUp/PgDn on keypad - go up/down a page.
Cursor left/right - move thru anim.
Shift Cursor left/right - move to start/end of anim.
Alt Cursor left/right - adjust slow-play speed.
Alt Cursor down - toggle slow play.
Cursor up - play
Cursor down - stop
Space bar - pause toggle
C - Convert
E - E/E
F - Field/Frame
G - Grab
I - still/anim convert mode
Q - Quit (or ESC)
R - Rename
T - TBC-IV
V - View

Requesters:

ESC - Cancel
C - Cancel
Return - OK
O - OK

Intentionally
Left
Blank

APPENDIX D

ARexx Commands

In Amiga systems, PAR can be controlled using ARexx commands. When PAR software is running, a public message port is opened which responds to ARexx messages in the function call format. The address of this message port is "DDR" and result option is set (Options results). The "SAY" command is only for programs run from a shell. (You won't see anything if it's run from PAR.) The command format is as described in the table below:

ARexx: (address is DDR)

F1.ddd through F10.ddd (S1.ddd - S10.ddd = Shift+FKKey) can be run from the F-keys.

Note: All examples assume current address is "DDR" (Address DDR), and result option is set (Options results). The SAY command is only for programs run from a shell. You won't see anything if it's run from PAR.

[] = optional argument

<> = required argument

APPEND	[OFF ON]	OFF ON
	Turn append on/off	

/* enable append mode */

Append On

if result~='ON' then say 'Append enable failed. Select an anim first.'

CAV	[MII BETA]	MII BETACAM
	Set output mode.	

/* Switch CAV output gain to Betacam */

CAV Betacam

CHECK <no arg> OPEN | CLOSED number

Returns DOS anim build window status, and current frame.

CLEANUP <no arg>
 Optimize the disk.

/* Optimize the PAR disk */
Cleanup

COLORS <hex numbers>

Colors 555 000 999 500 /* Set the screen color palette */

COPY <source> <destination> [start] [end] 1 = success
 Copies source anim/still to destination
 If destination project does not exist, it is created.

Copy 'DD0:Anims/Test' 'DD1:Anims' /* copy entire anim */
Copy 'DD0:Anims/Test' 'DD1:Anims' 20 199 /* copy 180 frames */

DELETE [file] [start] [end]
 delete currently selected file or specified file
 or frames in an animation

/* Select the file named "test" in project "Project1", and delete it */
Project 'Project1'
File 'test'
Delete
-or-
Delete 'DDR:Project1/test'

Delete 'DDR:Project1/test' 10 20 /* delete frames 10,11...20 */

See also: Project, File

DONE [name]

Same as hitting done in the DOS animation build status requester.
name is the optional name to save it as.

(This command is also used for manual record, without the filename)

/* Set convert mode to anim, convert all Framestores, complete the anim */
Mode Anim
Address command 'Copy DH1:Framestore/#? 'DDR:Project1/TestAnim'
Done

See also: Mode

DOSSELECT [stem]

returns all selected files in DOS requester.

stem.0 => number of selected files

stem.1 => first selected file (filenames, without path)

DOSselect files

if files.0~=0 then do i=1 to files.0

req files.i 'is selected'

end

EMODE [FRAME | 1 | 2 | BOTH] [DOUBLE] FRAME|1|2|BOTH
DOUBLE

Set current export mode

EMode FRAME /* saves full 480 line frame. */

EMode 1 /* saves field 1 as a 240 line file. */

EMode BOTH /* saves both 240 line fields as separate files. */

EMode 1 DOUBLE /* saves field 1 as a 480 line file. (every 2 lines are the same) */

See also: Export, Exporter

EMULATE [OFF | ON] OFF | ON

Turn emulation off or on.

EMULATE ON

ENDFRAME <number>

Set playback endframe (0 or OFF to turn off)

ENDFRAME 200

See also: StartFrame, Loop, Play

ETOE [OFF | ON] OFF | ON

/* Check the status of E/E */

ETOE

Say 'E/E is:' result

EXPORT [output_name] [start] [end] [start_ext]

Save frames to current DOS path as IFF24 or PAR images.

OUTPUT_NAME changes the name of the output files (do not specify path).

START and END are the range of frame for an anim.

START_EXT is the starting number to use as the extension.

Export /* Export still or current frame of anim */

Export 10 /* Export frame 10 of anim */

Export 1 30 /* Export frames 1 to 30 */

Export test 1 10 /* Export any name as test.0001, test.0002,

Export test 120 130 400 /*Exports frame 120-130 as test.0400, test.0401,

See also: EMode, Path, Exporter

EXPORTER [name]
Set export format

Exporter IFF
EMode FRAME
Export 1 30

FILE [name] current file name
Set file selection/play still or first frame of anim.

/* Switch to the "TestPatterns" project, show the still named "SMPTE_Bars" */

Project 'TestPatterns'
if result="" then say 'That project does not exist.'
File 'SMPTE_Bars'
if result="" then say 'That file does not exist.'

-or-

File 'DD1:Anims/Test1' /* optionally, the full path may be given */

See also: Project, Unit

FILTER [OFF | ON] OFF | ON
Set IFF conversion filter mode.

/* Turn filter on */
Filter On

FIELD[1 | 2] 1 | 2
Set field to display.

Stunt On /* enable field display */
Field 2 /* show field 2 */

See also: Stunt

FILM [OFF | ON] OFF | ON
 Turn film mode (24 fps) on or off.

/* Turn on film mode */
Film On

FPS [number] number
 Set frames per second playback, or record FPS.
 SLOW must be set to activate variable playback.

/* Play an anim at 7.5 frames per second, and wait for end. */
FPS 7.5
Slow ON
Loop OFF
Play 'TestAnim'
Wait
Slow OFF

FRAMES <no arg> number of frames
 Get number of frames in currently loaded anim.

File 'DD0:Anims/TestAnim'
Frames
n=result
if n=0 then Say 'Not an anim.'
else Say 'Anim has' n 'frames.'

FREE <no arg> number of blocks

Free
say 'The largest freespace is' result

GENLOCK [INT | EXT] INT | EXT
 Set sync reference mode.

GPI [ON | OFF] ON | OFF
 Turn GPI trigger on or off.

GRAB [filename]
 Grab a live frame. Will request a name if not given.

```
/* grab 8 frames from video source named "Test.1" thru "Test.8"
do i=1 to 8
    Grab 'Test.'i
end
```

HORIZ [number] number

```
/* Set genlock horizontal to .28 deg. */
Horiz 0.28
```

JOIN <name> <name> [name] ...
 Join a list of anim files together.
 The first name will be used as the joined name.

```
/* Join the files "test" and "test2" in the project "main" */
Join 'DD0:main/test' 'DD0:main/test2' 'DD1:Anims/endanim'
```

JUMP [frame] frame
 Jump to frame number in anim/get current frame number (0=no anim)

```
/* Load "TestAnim" and show frame 30 if it's an anim */
File 'TestAnim'
```

```
Jump
if result=0 then say 'This is not an anim'
else Jump 30
```

```
LAPSE      OFF | ON | seconds
          Set record time lapse speed, and turn on/off
```

```
/* Record time-lapse, and play it. Always set Lapse, QFactor, and
RecFrames */
Lapse On
Lapse 4
QFactor 10
RecFrames 30
Record 'LapseTest1'
Play
```

```
LIMIT [number]      number
          Set anim frame max encode size in blocks.
```

```
/* set maximum frames size limit for record/convert */
Limit 156
```

```
LOOP [ OFF | ON ]   OFF | ON
          Set anim looping mode.
```

```
/* Play current anim over and over again */
Loop On
Play
```

```
MANUAL  [ OFF | ON ]   OFF | ON
          Enable manual record
```

```
/* record a few frames */
```

RecFrames 10
 Manual ON
 QFactor 12
 Record 'testfile'
 Step /* same as hitting the GRAB button, or GPI */
 Step
 Step
 Done /* same as hitting the DONE button */

MODE [STILL | ANIM] Still | Anim
 Set import mode.

/* Import a Framestore as a still */
 Mode still
 Address command 'Copy DH1:Framestore/000.FS.VT4000 DDR:Stills'

MONO [OFF | ON] [OFF | ON]
 Turn monochrome on or off.

MOVE <source> <destination> 1 = success
 Moves source anim/still to destination
 If destination project does not exist, it is created.

Move 'DD0:Anims/Test' 'DD1:Anims'

PATH [dos_path] dos_path
 Set path in AmigaDOS file selector.

/* Change DOS selector to RAM: directory */
 Path 'RAM:'

PAUSE [OFF | ON | number] OFF | ON

Set pause state

If a number is given, it will unpause, wait until that frame, then pause.

```
/* Play selected anim, pause at frame 30, wait 1 sec, pause at 60, and stop at
90 */
Play
Pause 30
call delay 50
Pause 60
call delay 50
Stop 90
```

```
PLAY [filename]           0 | 1
    Show still/Start playing current anim, or start playing [filename]
    in current project.
```

```
/* play some anims at 30 FPS in sequence, waiting for each to end */
Project 'Anims'
Loop off
FPS 30
Play 'Anim1'
if result=0 then do;say 'Can''t play. File does not exist.';exit;end
Wait
Play 'Anim2'
Wait
Play 'Anim3'
Wait
Play 'DD1:OtherProject/Anim4' /* optionally give full path */
```

```
PROJECT [name]           current project name
    Set project selection.
```

```
Project 'Project1'
if result="" then Say 'No project by that name'
```



```
if result="" then say 'Cancel'  
else say 'The edit line was "'result'"'  
ToBack
```

```
SLOW[ OFF | ON ]      OFF | ON  
    Turn slow motion on/off.
```

```
/* Play anim at 15 FPS */  
FPS 15  
Slow ON  
Loop off  
Play  
if result=1 then say 'Playing....'  
Wait  
Say 'Stopped'
```

```
SMPTE      [ OFF | ON | time ] HH:MM:SS:FF ON | OFF
```

```
/* Start playing when Studio SMPTE counter reaches one second. */  
SMPTE 01:00  
SMPTE ON  
Pause ON  
Play
```

```
SPLIT <number> [filename]  
    Split current anim at frame <number>. If no filename is  
    given, it will request one.
```

```
/* Split the file "test" at frame 20, leaving file "test" with 20 frames,  
    and "test2" with the rest. */  
File 'ddr:anims/test'  
Split 20 'test2'
```

STARTFRAME <number>
Set playback startframe (0 or OFF to turn off)

```
/* loop from frame 10 to 30 */  
Startframe 10  
Endframe 30  
Loop ON  
Play
```

See also: Endframe,play

STEP <no args> 0 | 1 (1=done)
Frame step during manual record.

```
/* record 30 frames, one per second */  
Manual ON  
RecFrames 30  
Record 'live_test'  
done=0  
do while done=0  
    Step  
    done=result  
    call delay 50  
end
```

See also: Manual,Record,Done

STOP [number]
Stop playing. If a number is given, it will wait until that frame before stopping.

```
/* Jump to the beginning, start playing, stop at frame 30 */  
Jump 1  
Play  
Stop 30
```

See also: jump,play,pause

STUNT [OFF | ON] OFF | ON
Set field/frame output mode.

See also: Field

SUB [number] number
Set genlock sub-carrier

See also: Horiz

TITLE [string]
Put text in the title bar. No text resets to default.

Title 'Hello'
call delay 150
Title

TOFRONT <no arg>
Bring PAR screen to front

TOBACK <no arg>
Push PAR screen to back

TRANSLATE[OFF | ON] OFF | ON
Turn translate off or on

TRANSLATE ON

UNIT [0 | 1] [0 | 1]
Change to IDE drive 0 (master), or 1 (slave)

VERSION <no arg> current version ID

Get version info.

VIEW <filename>
Show an IFF24 or Framestore
filename can be full path+name, or name in current path

WAIT [number] RC=0|5
Wait for anim to complete, or wait for frame number.
RC will be 5 if not playing, or another ARExx program is waiting.

Loop OFF
say 'starting to play'
Play
say 'playing'
Wait
say 'Done'

Arexx Command Reference

APPEND	[OFF ON]	OFF ON
CAV	[MII BETA]	MII BETACAM
CHECK	<no arg>	OPEN CLOSED number
CLEANUP	<no arg>	
COLORS	<hex numbers>	
COPY	<source> <destination> [start] [end]	1 = success
DELETE	[file] [start] [end]	
DONE	[name]	
DOSSELECT	[stem]	
EMODE	[FRAME 1 2 BOTH] [DOUBLE]	FRAME 1 2 BOTH DOUBLE
EMULATE	[OFF ON]	OFF ON
ENDFRAME	<number>	
ETOE	[OFF ON]	OFF ON
EXPORT	[output_name] [start] [end] [start_ext]	
EXPORTER	[name]	
FILE	[name]	current file name
FILTER	[OFF ON]	OFF ON
FIELD	[1 2]	1 2
FILM	[OFF ON]	OFF ON
FPS	[number]	number
FRAMES	<no arg>	number of frames
FREE	<no arg>	number of blocks
GENLOCK	[INT EXT]	INT EXT
GPI	[ON OFF]	ON OFF
GRAB	[filename]	
HORIZ	[number]	number
JOIN	<name> <name>	[name] ...
JUMP	[frame]	frame
LAPSE	OFF ON seconds	
LIMIT	[number]	number
LOOP	[OFF ON]	OFF ON
MANUAL	[OFF ON]	OFF ON
MODE	[STILL ANIM]	Still Anim

MONO	[OFF ON]	[OFF ON]
MOVE	<source> <destination>	1 = success
PATH	[dos_path]	dos_path
PAUSE	[OFF ON number]	OFF ON
PLAY	[filename]	0 1
PROJECT	[name]	current project name
QFACTOR	0-23	0-23
QUIT	<no arg>	
RECFRAMES	[number]	number
RECORD	[filename]	
REQUEST	<line1 line2 line3;editline>	0 1 editline
SLOW	[OFF ON]	OFF ON
SMPTE	[OFF ON time]	HH:MM:SS:FF ON OFF
SPLIT	<number> [filename]	
STARTFRAME	<number>	
STEP	<no args>	0 1 (1=done)
STOP	[number]	
STUNT	[OFF ON]	OFF ON
SUB	[number]	number
TITLE	[string]	
TOFRONT	<no arg>	
TOBACK	<no arg>	
TRANSLATE	[OFF ON]	OFF ON
UNIT	[0 1]	[0 1]
VERSION	<no arg>	current version ID
VIEW	<filename>	
WAIT	[number]	RC=0 5

Intentionally
Left
Blank

APPENDIX E

Troubleshooting

Problem

PAR application does not start

Solution

If the PAR software does not start after double clicking on the PAR icon, check hardware installation. Make sure that the PAR card is properly inserted in the slot and the hard drive is connected directly to the PAR with the supplied 40 pin ribbon cable.

No video output

Video out is not connected to a video monitor. The PAR requires a video monitor with a composite input. An antenna input (RF input) cannot be used. Check cable connections and make sure that there are no loose or broken video cables.

Unable to allocate memory for RGB files

Not enough memory in system. Some other application is running and using all the memory. Try quitting ALL other applications, then try reimporting the files. This includes Lightwave, if Lightwave is setup to use fewer segments it could be using all available memory.

Drive does not seem to format

Formatting is very fast, it can take less than a second. Modern hard drives only require that the file information be cleared, which is very fast, even on large hard drives.

All operations seem locked-up

Make sure that the GPI button is not depressed. With the GPI button depressed the PAR will wait for a GPI input to do an operation. This includes Playing and Recording.

Problem

Solution

Real-time recording stops with an error	If during a real-time recording using the TBC IV an error occurs indicating that there is a block limit over run, reduce the Q-Factor until the recording is successful. The BLOCK LIMIT should be kept at the recommended block limit. (see Appendix A)
S-VHS or CAV output is dark	Only one of these can be connected at any one time , having both hooked up will reduce the video output levels.
Video glitching occurs	Block limit was set to high when files were saved to PAR hard drive. The block limit is set when frames are saved, the only way to change the block limit is to re-import the frames.
Drive is over heating.	The high performance drives used with the PAR will over heat if not cooled properly. It is essential to properly cool the drives. It is recommended to add an extra cooling fan, dedicated to the PAR drive to increase air flow around the drive. It is NOT recommended to operate the computer with the case removed. Cooling was designed to work only with the case closed With the case opened, proper air flow can not be maintained.
Hard drive is not one of the approved PAR Drives.	Drives on the approved list have been tested and are capable of sustaining the needed transfer rate for 30 frame per second video playback. Please refer to Appendix A, or call DPS for the latest approved drive list.
Hard drive is defective or cannot sustain needed transfer rates	If a drive has too many surface errors, throughput to sustain video playback cannot be maintained.

Problem

Solution

PAR will not exit

Some programs have a system lock on the PAR drive DDR. Try quitting all other programs. If this does not correct the problem, it will not hurt to turn the computer off without shutting down the PAR.

No ILBM found

The PAR can only accept one of the supported image formats, IFF, Framestore, Targa, SGI, or YUV (DPS proprietary). Any other format will cause an error, this includes any type of animation format including Framestore animations. The PAR requires single frames to generate animations.

Only part of image is shown

The PAR expects a resolution of 752x480. If the image is larger than 752x480 the PAR will crop the image, if the image is smaller the PAR will leave black borders around the image.

No video input from TBC-IV

If there is no video input from the TBC, check to make sure that the 50 pin CVE cable is hooked up properly. Verify that there is a video input by hooking a cable to the video out of the TBC to a monitor, the video should be passed to the monitor. Also, verify that the correct input is selected from the TBC-IV software (Composite/SVHS).

Video input from TBC IV is not stable

The PAR and TBC need to have the same reference sync in order to do frame capture. Verify that the video output from the PAR is connected to the Genlock input of the TBC IV, or verify that both the PAR and TBC have the same reference sync and that the PAR genlock mode is set for external. Also verify that the TBC IV software is in SLAVE mode.

Problem

Video output is not stable when input to a switcher

Fatal error, Board lockup

Solution

If the PAR is going to be used with a switcher, the PAR will need to be synced. To do this, feed the reference sync to the Genlock input of the PAR. Make sure that the software is also set for external sync.

This usually indicates that the PAR cannot communicate with the hard drive. If this occurs run the PARTest program. If all tests pass format the drive using PARTest. If an IDE error occurs, replace the hard drive.

APPENDIX F

FCC Compliance Statement

This device complies with Part 15 of FCC Rules. Operation is subject to the following two conditions:

1. This device may not cause harmful interference.
2. This device must accept any interference received, including interference that may cause undesired operation.

Notes:

This equipment has been tested and found to comply with the limits for a Class A digital device, pursuant to Part 15 of the FCC Rules. These limits are designed to provide reasonable protection against harmful interference in a commercial installation. This equipment generates, uses and can radiate radio frequency energy and if not installed and used in accordance with the instructions, may cause harmful interference to radio communications.

Operation of this equipment in a residential area is likely to cause harmful interference in which case the user will be required to correct the interference at his own expense. Shielded cables must be used with this unit to ensure compliance with the Class A FCC limits.

Warning:

Changes or modifications to this unit not expressly approved by Digital Processing Systems, Incorporated could void the user's authority to operate the equipment.

Intentionally
Left
Blank

APPENDIX G

Warranty

Digital Processing Systems Inc. warrants the original purchaser that this product is in good working condition for a period of two years from the date of purchase. Should this product, in Digital Processing System's opinion, malfunction within the warranty period, Digital Processing Systems Inc. will repair or replace this product without charge. This warranty does not apply to those products which have been damaged due to accident, unauthorized alterations, repairs or modifications.

Limitations

All warranties for this product, expressed or implied, are limited to two years from the date of purchase and no warranties, expressed or implied, will apply after that period.

The distributor, its dealers and customers agree that Digital Processing Systems Inc. shall not be liable for any loss of use, revenue or profit.

Digital Processing Systems Inc. makes no other representations of warranty as to fitness for purpose of merchantability of otherwise in respect to any of the products sold to the distributor pursuant to this agreement.

The liability of Digital Processing Systems Inc. in respect of any defective products will be limited to the repair or replacement of such products.

In no event shall Digital Processing Systems Inc. be responsible or liable for any damages arising from the use of such defective products whether such damages be direct, indirect, consequential or otherwise and whether such damages are incurred by the distributor or third party.

Warranty Service

Units requiring repair under warranty may be sent directly to Digital Processing Systems Inc. To obtain service under this warranty, first contact the Digital Processing Systems Customer Service Department to request a Return Material Authorization Number (RMA).

U.S.A.	(606) 371-5533
Canada and International	(416) 754-8090
Europe	(0232) 718300

This number must be clearly displayed on the units external packaging. Units shipped without an RMA number will not be accepted. Include proof of purchase (including date of purchase), a note outlining the problem and the RMA number.

IMPORTANT: When shipping your unit, pack it securely and ship prepaid and insured. Digital Processing Systems Inc. will not be held liable for damage or loss to the product in shipment. Repaired items will returned to the purchaser prepaid via a surface freight carrier of DPS' choice within the continental United States. If another method of shipping is desired, it must be clearly specified in writing and all priority return freight charges are the responsibility of the purchaser.

